

# Megger<sup>®</sup>



## **MFT-X1** Multifunction tester

*User Guide*

**This document is copyright of:**  
Megger Limited, Archcliffe Road, Dover, Kent CT17 9EN. ENGLAND  
T +44 (0)1304 502101 F +44 (0)1304 207342 [www.megger.com](http://www.megger.com)

Megger Ltd reserves the right to alter the specification of its products from time to time without notice. Although every effort is made to ensure the accuracy of the information contained within this document it is not warranted or represented by Megger Ltd. to be a complete and up-to-date description.

For Patent information about this instrument refer to the following web site:

[megger.com/patents](http://megger.com/patents)

This manual supersedes all previous issues of this manual. Please ensure that you are using the most recent issue of this document. Destroy any copies that are of an older issue.

### **Declaration of Conformity**

Hereby, Megger Instruments Limited declares that radio equipment manufactured by Megger Instruments Limited described in this user guide is in compliance with Directive 2014/53/EU. Other equipment manufactured by Megger Instruments Limited described in this user guide is in compliance with Directives 2014/30/EU and 2014/35/EU where they apply.

The full text of Megger Instruments EU declarations of conformity are available at the following internet address:

**[megger.com/eu-dofc](http://megger.com/eu-dofc)**

# Contents

---

|  |           |
|--|-----------|
| <b>1. Introduction</b>                                   | <b>10</b> |
| 1.1 Product description                                  | 10        |
| 1.2 Features   | 11        |
| 1.3 Company web site                                     | 11        |
| 1.4 Firmware updates                                     | 11        |
| <b>2. Safety Warnings</b>                                | <b>12</b> |
| 2.1 Warnings, Cautions and Notes                         | 12        |
| 2.2 Safety warnings                                      | 12        |
| 2.2.1 Earth test warnings                                | 13        |
| 2.2.2 Li-ion battery module warnings                     | 14        |
| 2.2.3 Li-ion battery care                                | 14        |
| 2.3 Product safety category – measurement connection     | 14        |
| 2.3.1 Safety category voltage                            | 14        |
| 2.3.2 CAT IV   | 14        |
| 2.3.3 CAT III  | 14        |
| 2.3.4 CAT II   | 14        |
| 2.4 Safety, Hazard and Warning symbols on the instrument | 15        |
| 2.5 Warning icons  | 15        |
| 2.5.1 Connection terminals                               | 15        |
| <b>3. Getting started</b>                                | <b>16</b> |
| 3.1 Quick start (for those in a hurry)                   | 16        |
| <b>4. Instrument Controls</b>                            | <b>17</b> |
| 4.1 Instrument layout                                    | 17        |
| 4.2 Instrument display                                   | 18        |
| 4.2.1 Colour coded backgrounds                           | 18        |
| 4.2.2 High contrast mode                                 | 19        |
| 4.3 Instrument controls                                  | 19        |
| 4.3.1 The left-hand rotary knob                          | 19        |
| 4.3.2 The right-hand rotary knob                         | 19        |
| 4.3.3 Information bar                                    | 20        |
| 4.3.4 Test lead connection guide                         | 21        |
| 4.3.5 Voltage widget                                     | 22        |
| 4.3.6 Terminal voltage anomalies (floating voltages)     | 22        |
| 4.3.7 Analogue arc                                       | 23        |
| <b>5. Operation</b>                                      | <b>24</b> |
| 5.1 Switching on and off                                 | 24        |
| 5.1.1 Auto power off (sleep function)                    | 25        |
| 5.2 Test inhibit – general inhibits                      | 25        |

|  |           |
|--|-----------|
| <b>6. Dead circuit tests .....</b>   | <b>26</b> |
| 6.1 General.....   | 26        |
| 6.2 Protection against accidental damage.....                                | 26        |
| <b>7. Continuity testing and resistance measurement .....</b>                | <b>27</b> |
| 7.1 General information .....  | 27        |
| 7.1.1 Basic functions .....  | 27        |
| 7.1.2 Test inhibit .....   | 28        |
| 7.1.3 Hot keys for continuity checking and resistance measurement.....       | 28        |
| 7.2 Continuity testing.....  | 29        |
| 7.3 Test lead null.....  | 30        |
| 7.3.1 To null a test lead:.....  | 30        |
| 7.3.2 To check the lead null value.....                                      | 31        |
| 7.3.3 To remove a test-lead null:.....                                       | 31        |
| 7.3.4 To update a test-lead null value .....                                 | 31        |
| 7.3.5 Lead null errors .....   | 31        |
| 7.3.6 Sources of errors in measurement .....                                 | 32        |
| 7.4 Buzzer mode up to 2 k $\Omega$ (1 k $\Omega$ on analogue scale).....     | 32        |
| 7.5 Bi-directional continuity.....   | 33        |
| <b>8. Insulation testing .....</b>   | <b>34</b> |
| 8.1 General.....   | 34        |
| 8.2 Test starting timer .....  | 34        |
| 8.2.1 Insulation test-inhibit.....   | 35        |
| 8.3 Hot keys for insulation tests .....                                      | 35        |
| 8.4 All insulation tests .....   | 35        |
| 8.5 Insulation testing.....  | 36        |
| 8.6 Insulation test with test lock.....                                      | 37        |
| <b>9. Earth resistance measurement .....</b>                                 | <b>39</b> |
| 9.1 General.....   | 39        |
| 9.1.1 Terminal designations.....   | 39        |
| 9.1.2 Earth testing inhibit.....   | 39        |
| 9.1.3 Two-pole earth resistance measurements.....                            | 40        |
| 9.1.4 Three-pole earth resistance measurements without a current clamp ..... | 40        |
| 9.2 Hot keys for earth resistance measurement .....                          | 41        |
| 9.3 Two-pole (2P) earth resistance measurements .....                        | 41        |
| 9.4 Three-pole (3P) earth resistance measurements without current clamp..... | 42        |

|   |           |
|---|-----------|
| <b>10. Live circuit tests</b> .....                               | <b>44</b> |
| 10.1 General.....   | 44        |
| 10.2 Warning indication.....                                      | 44        |
| 10.3 Auto-start (hands-free) option .....                         | 44        |
| 10.4 Protective earth and touch voltage warnings .....            | 45        |
| 10.4.1 Protective earth warning (PE) operation .....              | 45        |
| 10.4.2 Inhibit protective earth confirmation (PE warning) .....   | 45        |
| 10.5 Touch voltage (fault voltage) .....                          | 46        |
| <b>11. Voltage measurement</b> .....                              | <b>47</b> |
| 11.1 General.....   | 47        |
| 11.2 Hot keys for voltage measurements.....                       | 48        |
| 11.3 Display for voltage measurements .....                       | 48        |
| 11.4 All voltage measurements .....                               | 48        |
| 11.5 Single-phase measurements .....                              | 49        |
| 11.6 Three-phase measurements.....                                | 50        |
| 11.7 Phase sequence.....  | 50        |
| 11.8 Millivolt measurements.....                                  | 51        |
| 11.9 Frequency measurement.....                                   | 51        |
| 11.10 Sending results to a Bluetooth® device.....                 | 51        |
| <b>12. Current measurement</b> .....                              | <b>52</b> |
| 12.1 General.....   | 52        |
| 12.2 Hot keys for current measurements.....                       | 52        |
| 12.3 All current measurements.....                                | 53        |
| 12.4 Current measurements.....                                    | 53        |
| <b>13. Residual current device (RCD) testing</b> .....            | <b>54</b> |
| 13.1 General.....   | 54        |
| 13.1.1 Types of RCD supported .....                               | 54        |
| 13.1.2 RCD test current.....                                      | 54        |
| 13.1.3 About the RCD tests .....                                  | 55        |
| 13.1.4 The ½ x I test .....                                       | 55        |
| 13.1.5 The 1 x I test .....                                       | 55        |
| 13.1.6 The 2 x I test .....                                       | 55        |
| 13.1.7 The 5 x I test .....                                       | 56        |
| 13.1.8 The ramp test.....   | 56        |
| 13.1.9 Testing at 0° and 180° .....                               | 56        |
| 13.1.10 RCD testing inhibit .....                                 | 56        |
| 13.1.11 Sources of error in measurements .....                    | 56        |
| 13.2 Hot keys for RCD tests.....                                  | 57        |
| 13.3 Display layout for RCD tests (AUTO TEST example shown) ..... | 57        |
| 13.4 Touch voltage – All RCD, RDC and touch voltage tests.....    | 57        |

|            |   |           |
|------------|---|-----------|
| 13.5       | Automatic RCD testing.....  | 58        |
| 13.5.1     | Customising the AUTO test sequence.....   | 59        |
| 13.6       | RCD testing at a single current.....  | 59        |
| 13.7       | 3 Phase RCD testing.....  | 61        |
| 13.8       | Ramp testing RCDs.....  | 62        |
| 13.9       | Touch-voltage test.....   | 63        |
| 13.10      | VAR (Variable RCD).....   | 64        |
| 13.10.1    | Using the VAR option.....   | 64        |
| 13.10.2    | Setting the VAR option.....   | 65        |
| <b>14.</b> | <b>Earth Loop Impedance testing – TrueLoop™.....</b>                                  | <b>66</b> |
| 14.1       | General.....  | 66        |
| 14.1.1     | About Loop Impedance tests.....   | 66        |
| 14.1.2     | Using the Confidence Meter™.....  | 67        |
| 14.2       | Loop test options.....  | 68        |
| 14.2.1     | Hot key 1 – Types of loop test.....   | 68        |
| 14.2.2     | Hot key 2 – No RCD, RCD or EV RDC options.....  | 68        |
| 14.2.3     | Hot key 3 – No RCD, RCD or EV RDC options.....  | 69        |
| 14.2.4     | Hot key 4 – 2 wire, 2 wire HR and 3 wire methods.....                                 | 69        |
| 14.2.5     | Hot key 5 – test-lead connections.....  | 69        |
| 14.2.6     | Test inhibit.....   | 70        |
| 14.3       | Hot keys for Loop Impedance tests.....  | 70        |
| 14.4       | Test-lead null.....   | 71        |
| 14.5       | Loop test recommendation table.....   | 71        |
| 14.6       | Measuring Loop Impedance – No RCD in circuit.....                                     | 72        |
| 14.7       | Measuring Loop Impedance (Zs) with RCD protection in circuit (3 wire).....            | 73        |
| 14.8       | Measuring EV charger Loop Impedance.....  | 74        |
| 14.9       | Zmax – to find the highest Loop Impedance for a circuit.....                          | 74        |
| 14.10      | Zref – making and using the reference impedance for R1+R2 and Vdrop calculations..... | 76        |
| 14.11      | R1 + R2 mode.....   | 78        |
| 14.12      | Setting i-vdrop for volts drop measurements.....                                      | 79        |
| 14.12.1    | Volt drop.....  | 79        |
| 14.12.2    | Setting Zref.....   | 79        |
| 14.12.3    | Setting i-vdrop.....  | 80        |
| 14.12.4    | Making a Volt drop measurement.....   | 81        |
| 14.12.5    | Sources of error in measurements.....   | 81        |
| <b>15.</b> | <b>Instrument settings navigation.....</b>  | <b>82</b> |
| 15.1       | Settings screen navigation.....   | 82        |
| 15.2       | Hot keys in settings mode.....  | 82        |
| 15.3       | Entering and leaving settings mode.....   | 83        |
| 15.4       | Selecting a settings page.....  | 83        |

|              |  |           |
|--------------|--|-----------|
| <b>15.5</b>  | <b>General settings</b> .....                        | <b>83</b> |
| 15.5.1       | Screen brightness.....                               | 84        |
| 15.5.2       | Backlight timer.....                                 | 84        |
| 15.5.3       | Contrast mode.....                                   | 84        |
| 15.5.4       | Setting the date.....                                | 84        |
| 15.5.5       | Setting the time.....                                | 85        |
| 15.5.6       | Key press beep.....                                  | 85        |
| 15.5.7       | Results beep.....                                    | 85        |
| 15.5.8       | Sleep timer.....                                     | 86        |
| 15.5.9       | Language.....  | 86        |
| 15.5.10      | PE confirmation.....                                 | 86        |
| 15.5.11      | Network connection.....                              | 87        |
| 15.5.12      | Clear network pairings.....                          | 87        |
| 15.5.13      | Reset to factory settings.....                       | 87        |
| <b>15.6</b>  | <b>Continuity test settings R<sub>LO</sub></b> ..... | <b>88</b> |
| 15.6.1       | Continuity buzzer threshold (limit alarm).....       | 88        |
| <b>15.7</b>  | <b>Insulation resistance settings</b> .....          | <b>88</b> |
| 15.7.1       | Live voltage limit.....                              | 88        |
| 15.7.2       | Lock button available.....                           | 89        |
| 15.7.3       | Variable voltage.....                                | 89        |
| 15.7.4       | Insulation buzzer threshold (limit alarm).....       | 89        |
| 15.7.5       | 1000 V test.....                                     | 89        |
| <b>15.8</b>  | <b>Loop impedance settings</b> .....                 | <b>90</b> |
| 15.8.1       | Allow reverse polarity.....                          | 90        |
| 15.8.2       | Maximum touch voltage.....                           | 90        |
| 15.8.3       | Auto start test.....                                 | 90        |
| <b>15.9</b>  | <b>RCD test settings</b> .....                       | <b>91</b> |
| 15.9.1       | Allow reverse polarity.....                          | 91        |
| 15.9.2       | Maximum touch voltage.....                           | 91        |
| 15.9.3       | Auto start test.....                                 | 91        |
| 15.9.4       | Ramp test speed.....                                 | 91        |
| 15.9.5       | Maximum test time ½ x I.....                         | 92        |
| 15.9.6       | Maximum test time 1 x I.....                         | 92        |
| 15.9.7       | Auto sequence customisation.....                     | 92        |
| <b>15.10</b> | <b>Instrument information</b> .....                  | <b>92</b> |



|  |            |
|--|------------|
| <b>16. Download results to a remote device.....</b>                    | <b>93</b>  |
| 16.1 Creating a CertSuite™ account .....                               | 93         |
| 16.2 Installing CertSuite™ on a mobile device .....                    | 93         |
| 16.3 Switching on the MFT-X1 Bluetooth® mode .....                     | 94         |
| 16.4 Connecting to the MFT-X1 from CertSuite™ .....                    | 94         |
| 16.5 Failure to connect.....   | 95         |
| 16.6 Sleep mode and power cycling the MFT-X1.....                      | 95         |
| 16.7 Sending test results to CertSuite™ .....                          | 96         |
| 16.8 Re-sending test results to CertSuite™ .....                       | 96         |
| 16.9 Further CertSuite information and support.....                    | 96         |
| <b>17. Updating the operating system .....</b>                         | <b>97</b>  |
| 17.1 To update your instrument operating system: .....                 | 97         |
| 17.1.1 Download the latest operating system onto microSD card .....    | 97         |
| 17.1.2 Installing the latest operating system to your instrument ..... | 98         |
| 17.1.3 System update – Error messages.....                             | 100        |
| 17.1.4 Error during the automatic update process: .....                | 100        |
| <b>18. Service and maintenance.....</b>                                | <b>101</b> |
| 18.1 General maintenance .....   | 101        |
| 18.2 Cleaning .....  | 101        |
| 18.3 Batteries and battery replacement.....                            | 101        |
| 18.3.1 Battery and fuse assembly .....                                 | 102        |
| 18.3.2 Battery status .....  | 103        |
| 18.3.3 Lithium-ion battery pack – removal and replacement.....         | 104        |
| 18.3.4 Lithium-ion battery pack – charging .....                       | 105        |
| 18.4 Battery disposal .....  | 105        |
| 18.5 Fuse and fuse replacement .....                                   | 106        |
| <b>19. Specifications.....</b>   | <b>107</b> |
| <b>20. Accessories and equipment.....</b>                              | <b>112</b> |
| 20.1 Included accessories.....   | 112        |
| 20.2 Optional accessories .....  | 112        |
| <b>21. Calibration, Repair and Warranty .....</b>                      | <b>113</b> |
| 21.1 Return procedure .....  | 113        |
| <b>22. Decommissioning .....</b>                                       | <b>114</b> |
| 22.1 WEEE Directive .....  | 114        |
| 22.2 Battery disposal .....  | 114        |
| <b>23. Worldwide Sales Offices.....</b>                                | <b>115</b> |

## 1. Introduction

---

This guide explains how to use multifunction installation testers in the Megger MFT-X1.

Please read the guide carefully before you start using your MFT-X1.

### 1.1 Product description

The MFT-X1 is a multifunction tester designed primarily for testing electrical installations to meet the requirements of international regulations and standards. It has been designed with safety, versatility, ease of use and reliability in mind and it has an entirely new user interface that simplifies and speeds up testing as well as greatly reducing the risk of errors.

The MFT-X1 also supports user upgradeable firmware, through the removable microSD card.

The main functions of the MFT-X1 are:

- Voltage, frequency, and current measurement (using current clamp)
- Continuity testing and resistance measurement
- Insulation resistance testing
- Loop impedance testing and short-circuit current evaluation
- Volt drop measurement
- Residual current device (RCD) testing
- Touch voltage measurement
- Earth resistance measurement (2 wire and 3 wire)

## 1.2 Features

The MFT-X1 introduces many new features that help users to work more safely and more productively. Some of the most important of these are:

- No tools, quick release, safe battery design
- Simple user interface with colour-coded display screens
- User upgradeable operating system
- TrueLoop™ circuit impedance testing
- High resolution Loop Impedance to 0.001  $\Omega$
- Confidence Meter™
- User configurable RCD auto-sequence
- RCD testing for 10 mA to 1000 mA devices
- RCD testing for AC, DC sensitive and pure DC devices
- RDC and type B testing for EV charge points
- Full colour 480 x 272 TFT / Monochrome display configurations
- Scratch proof hardened glass display
- Fully bonded screen
- Innovative integration of rotary knobs and graphical display
- Time and date stamped measurement results (Lithium coin cell)
- Unique modular Lithium Ion battery solution
- Multi-language interface
- On-screen graphical help
- Continuous voltage screen widget
- IP54 for outdoor use

## 1.3 Company web site

Occasionally an information bulletin may be issued via the Megger web site. This may be new accessories, new usage instructions or a software update. Please occasionally check on the Megger web site for anything applicable to your Megger instruments.

[www.megger.com](http://www.megger.com)

## 1.4 Firmware updates

In accordance with Megger's policy of continuous improvement, from time-to-time Megger releases new instrument firmware revisions to provide new features and to enhance safety and performance of its products. Please consult the Megger website regularly for details of the latest firmware releases. Scan the QR code to see the latest Firmware updates →

Visit [megger.com/mft-x1](http://megger.com/mft-x1) for more information



## 2. Safety Warnings

These safety warnings are indicative of safe practice and must be followed. Additionally, they do not replace local safety procedures in the region where the instrument is used. These safety warnings must be read and understood before the instrument is used. Retain for future reference. This instrument must be operated only by suitably trained and competent people. Protection provided by the instrument, test leads or probes may be impaired if they are not used in a manner specified by the manufacturer.

### 2.1 Warnings, Cautions and Notes

This user guide follows the internationally recognized definition of warnings, cautions and notes. These instructions must always be adhered to.

| Description   |
|---|
| <b>DANGER :</b> Indicates a dangerous situation which, if ignored, could lead to death, serious injury or health problems.              |
| <b>WARNING :</b> Indicates a potentially dangerous situation which, if ignored, could lead to death, serious injury or health problems. |
| <b>ATTENTION :</b> Indicates a dangerous situation which, if ignored, could lead to injuries or health problems.                        |
| <b>CAUTION :</b> Indicates a situation which could lead to damage of the equipment or environment                                       |
| <b>NOTE :</b> Indicates important instructions to be followed to perform the relevant process safely and efficiently.                   |

### 2.2 Safety warnings

These safety warnings must be read and understood before the instrument is used. Retain for future reference.

**WARNING :** This instrument must be operated only by suitably trained and competent people. Protection provided by the instrument may be impaired if it is not used in a manner specified by the manufacturer.

- Local Health and Safety Legislation requires users of this equipment and their employers to carry out valid risk assessments of all electrical work to identify potential sources of danger and risk of electrical injury such as inadvertent short circuits. Where the assessments show that the risk is significant then the use of fused test leads may be appropriate.
- Replacement fuses must be of the correct type and rating. Failure to fit the correctly rated fuse will result in fire hazards and damage the instrument in the event of an overload.
- Do not operate the instrument or connect it to any external system if it shows visible signs of damage or if it has been stored for prolonged time in an environment outside its specification.
- This product is not intrinsically safe. Do not use in an explosive atmosphere.
- The circuit under test must be switched off, de-energized, securely isolated, and proved dead before test connections are made when carrying out insulation and continuity tests.
- Continuity of protective conductors and earthed equipotential bonding of new or modified installations must be verified before carrying out an earth fault Loop Impedance or RCD test.
- After an insulation test, the instrument must be left connected until the circuit has been discharged to a safe voltage.
- The instrument will not discharge the circuit after an insulation test if the test has been locked on. In this case, the circuit must be discharged by other means.
- Do not touch circuit connections and exposed metalwork of an installation or equipment under test. Under fault conditions the system earth could become hazardous live.

- Do not touch the earth stakes, test leads, or their terminations (including connections to the earthing system under test) if an installation earth fault can arise, unless adequate precautions are taken.
- The Voltmeter function will operate only if the instrument is switched on and working correctly.
- Before and after use always test a known voltage to check for correct instrument operation. Do not use the instrument if incorrect results are obtained.
- The 'live circuit warning' and 'automatic discharge' features must be regarded as additional safety features and not a substitute for normal safe working practice which **MUST** be followed.
- The purpose of RCD testing is to verify the proper function of protective devices. Do not rely on the RCD test's polarity checking feature to verify correct wiring of the installation, which must be verified independently using specific tests for that purpose.
- Only Megger approved test leads must be used with this product.
- All test leads, probes and crocodile clips must be in good order, clean, and with no broken or cracked insulation. Verify the integrity of the test leads before use. In particular, the insulation on the red fine-point probe must be intact to reduce the risk of short-circuit and arc-flash explosion. If more than 4 mm of metal is exposed, the probe must be disposed of and not used.
- The mains test lead provided with the instrument must be used only by suitably trained and competent persons. Never connect test probes, pins or other objects to the three lead plugs because of the danger of electrocution and arc explosion.
- Replacement fuses of fused test leads must be of the correct type and rating as marked on the leadset.
- Disconnect the fused leadset from the instrument and the circuit under test before changing the fuse.
- Ensure that hands remain behind guards of probes/clips when testing.
- Always disconnect test leads from instrument and power down the instrument before disconnecting the battery module.
- The battery module must be replaced in a clean and dry environment.
- Do not heat or dispose of the battery in a fire. Do not subject the battery to strong impact, mechanical shock or excessive heat.
- Do not short-circuit or reverse the polarity of the battery module.
- The instrument must be set to OFF before the instrument is prepared for shipping.
- The fuse cover located under the battery module must be fitted correctly before connecting the battery module or protection will be compromised.
- There are no user serviceable parts inside the instrument. Other than opening the fuse cover for the purpose of replacing the fuses and performing firmware upgrades, do not disassemble the instrument.

### 2.2.1 Earth test warnings

- When measuring resistance of an earth electrode while the distribution system is energised, the following additional warnings apply.
- All persons involved must be trained and competent in isolation and safety procedures for the system to be worked on. They must be clearly instructed not to touch the earth electrode, test stakes, test leads, or their terminations as 'Live' earths may be encountered. It is recommended that they wear appropriate rubber gloves, rubber soled shoes, and stand on a rubber mat.
- The earth electrode under test must be isolated from the circuit it is protecting before testing commences. If this is not possible, ART (Attached Rod Technique) may be used to measure electrode resistance.
- The instrument terminals must be connected to the system under test through isolation switches that are rated to handle the likely maximum fault voltages and currents that could be encountered at the installation. The isolation switch must be open whilst any personal contact is made with the remote test stakes, or the connecting leads, e.g. when changing their position.
- The instrument terminals should be connected to the system under test through fuses that are rated to handle the likely maximum fault voltages and currents that could be encountered at the installation.
- Special precautions are necessary when working in wet conditions or in agricultural areas: observe the local safety standards and take all necessary special precautions applicable to the particular location and do not touch the test leads with bare hands.

## Safety Warnings

### 2.2.2 Li-ion battery module warnings

- This instrument may be provided with a Lithium-Ion high energy battery module.
- Do not pierce, damage, disassemble or modify the battery module. The battery module contains safety and protection devices which, if tampered with, may cause the battery to generate heat, rupture or ignite.
- If a battery is suspected to be faulty, replace it with a Megger approved battery module.
- If an instrument is suspected to contain a faulty battery module, the module must be removed before the instrument is shipped.
- Do not ship a faulty battery module, either separately or connected to an instrument.
- The battery module must be charged only with an MBC2100 Li-ion battery charger in a dry environment.

### 2.2.3 Li-ion battery care

- Only use the charger supplied by Megger Instruments Limited.
- Please fully charge the Li-ion battery before using it for the first time. The green LED on the battery indicates normal charging. Disconnect the charger from the battery after the LED on the charger has changed to green colour.
- The red LED will illuminate if the cell temperature is outside of 0 °C to 40 °C charging range.
- The red LED can also illuminate if the wrong charger has been used such that the charging current is greater than 4 A.

## 2.3 Product safety category – measurement connection

The product safety category, in accordance with IEC 61010, determines which parts of an electrical installation an instrument may be safely used on. The category ratings are explained below. When used with approved Megger test-leads, MFT-X1 instrument has a CAT IV 300 V and CAT III 600 V rating, but with some accessories, this rating may be reduced. The reductions will be explained in the sections dealing with these modes and accessories.

**WARNING : When using a test instrument, the applicable product safety category is always that of the lowest rated component in the measurement circuit.**

### 2.3.1 Safety category voltage

The voltage that forms part of the category rating (CAT IV **300 V** or CAT III **600 V**) is the maximum line-to-earth voltage to which the instrument can be connected on that type of circuit.

### 2.3.2 CAT IV

Instruments with a CAT IV safety rating can be connected to circuits between the origin of the low-voltage mains power supply and the distribution panel, provide that there is at least one protective device between the origin of the supply and the point of connection of the instrument. If there is no such protective device, a temporary protective device should be fitted. Alternatively, subject to the outcome of a risk assessment, it may be permissible to use fused test-leads. Instruments with a CAT IV safety rating can also be connected to circuits between the distribution panel and the electrical outlets and to circuits between the electrical outlets and the user equipment.

### 2.3.3 CAT III

Equipment with a CAT III safety rating can be connected to circuits between the distribution and the electrical outlets, and to equipment between the electrical outlets and the user's equipment

### 2.3.4 CAT II

Equipment with a CAT II safety rating can be connected to circuits between the electrical outlets and the user's equipment. Measurement equipment may be safely connected to circuits at the marked rating or lower. The connection rating is that of the lowest rated component in the measurement circuit.

## 2.4 Safety, Hazard and Warning symbols on the instrument

This section details the various safety and hazard icons on the instruments outer case.

| Icon | Description  |
|------|--|
|      | Warning: High Voltage, risk of electric shock                                |
|      | Caution: Refer to user guide   |
|      | Equipment complies with current EU directives                                |
|      | Equipment complies with current UK conformity requirements                   |
|      | Equipment complies with Australian and New Zealand conformity requirements   |
|      | Do not dispose of to landfill, sewage systems or by fire                     |
|      | Equipment protected throughout by double insulation or reinforced insulation |
|      | Terminal is fused  |
|      | Do Not Open. No serviceable parts inside                                     |
|      | Green LED indicates battery module is being charged                          |
|      | Refer to manual when red LED is lit  |
|      | Lithium-Ion battery module connections                                       |
|      | Category III 600 V measurement connection rating                             |
|      | Category IV 300 V measurement connection rating                              |
|      | Follow local recycling guidelines for Lithium Ion batteries                  |
|      | Do not use in distribution systems with voltages higher than 600 V AC RMS    |

## 2.5 Warning icons

This section details the warning icons that can show on the display.

| Icon | Warning                  | Description                                       |
|------|--------------------------|---|
|      | External Voltage Warning | Hazardous voltage exists on measurement terminals |
|      | Internal Error Warning   | An error has occurred requiring attention         |

### 2.5.1 Connection terminals

This section relates to the explanation of the symbol on the top left of the terminal panel label: Unmated terminals can be energized from within the instrument and from external connection of other terminals. The current clamp must be the type indicated as "MCC1010" to ensure safe connection to the instrument.

### 3. Getting started

This section describes the basic layout of the instrument, the navigation controls and the screen layout that is common to all measurements. It is strongly recommended the user familiarizes themselves with the full user guide, as there is a great deal of information on how the measurement works as well as how to get the most from your instrument.

#### 3.1 Quick start (for those in a hurry)

To get going quickly here is a summary of controls and tests.

- Ensure a battery has been fully charged.
- Turn the instrument on by rotating the left rotary knob to the main test mode required. The display will also show which function is being selected.
- The Hot keys at the top of the display allow each test mode to be customized as required.
- A Hot key with more than two options can be pressed several times to scroll through the options.
- Alternatively, the right range knob can be used to scroll through options very quickly, displaying the options in an arc similar to the left range knob. Press the required Hot key first then turn the right hand knob.
- The INFO bar at the bottom shows the terminal connections recommended, as below:

|  | Voltage | Continuity | Insulation | Loop impedance | RCD     | Earth resistance | Current clamp |
|--|---------|------------|------------|----------------|---------|------------------|---------------|
|  | ✓ (1)   | ✓          | ✓          | ✓              | ✓ (2)   |                  |               |
|  | ✓       |            |            | ✓ (3)          |         |                  |               |
|  | ✓       |            |            | ✓              | ✓ (2/3) |                  |               |
|  |         |            |            |                |         | ✓                |               |
|  |         |            |            |                |         |                  |               |
|  |         |            |            |                |         |                  | ✓ (4)         |

**Fig 1: Terminal selection table**

1. Provides all three voltages on single or 3 phase systems simultaneously.
  2. 2 wire testing is OK for AC and A type RCDs but RDC and type B devices require three wire connection.
  3. Connecting the neutral provides reverse polarity detection
  4. Connection for MCC1010 in current mode
- Depending on the test mode selected the test will either start automatically or require the TEST button to be pressed as below:

|                          |  |
|--------------------------|--|
| <b>Voltage:</b>          | Starts automatically on selection  |
| <b>Continuity:</b>       | Starts automatically on selection  |
| <b>Insulation:</b>       | Starts when TEST button is held down<br>Releasing test button stops test                     |
| <b>Earth resistance:</b> | Starts when TEST button is pressed and released<br>Stops automatically on completion of test |
| <b>Loop Impedance:</b>   | Starts when TEST button is pressed and released<br>Stops automatically on completion of test |
| <b>RCD:</b>              | Starts when TEST button is pressed and released<br>Stops automatically on completion of test |



## 4. Instrument Controls

### 4.1 Instrument layout

The front panel of your MFT-X1 multifunction tester has four main areas:

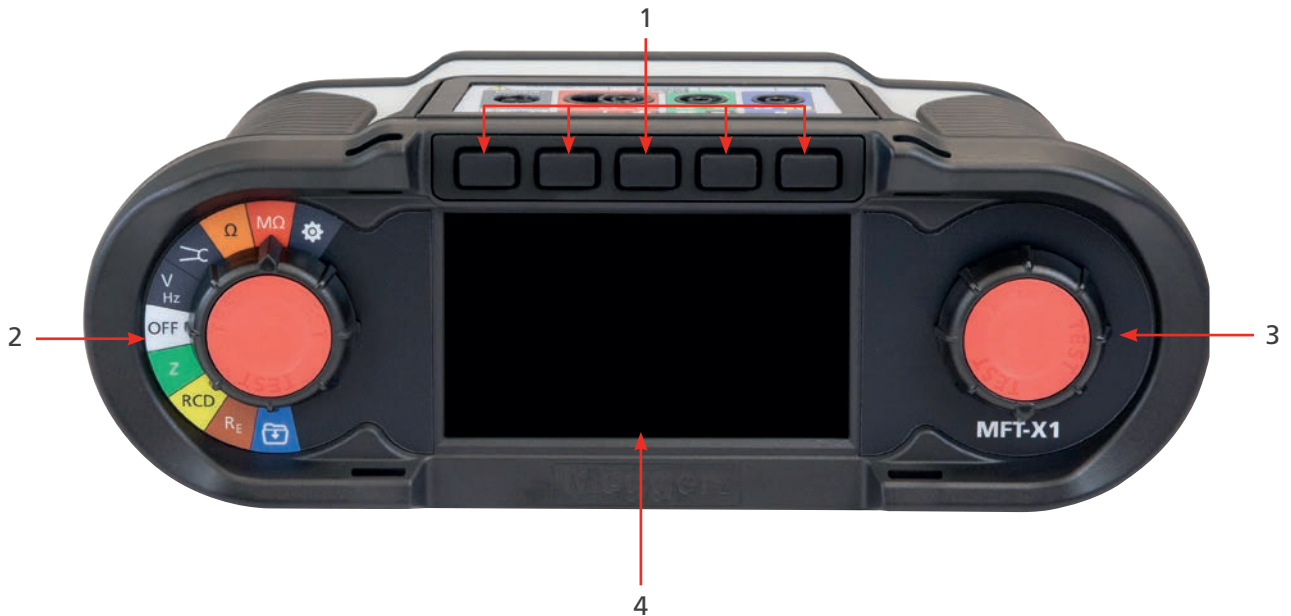

| Item | Description                  | Item | Description                    |
|------|------------------------------|------|--------------------------------|
| 1    | Hot keys                     | 3    | Secondary rotary selector knob |
| 2    | Primary rotary selector knob | 4    | Display                        |

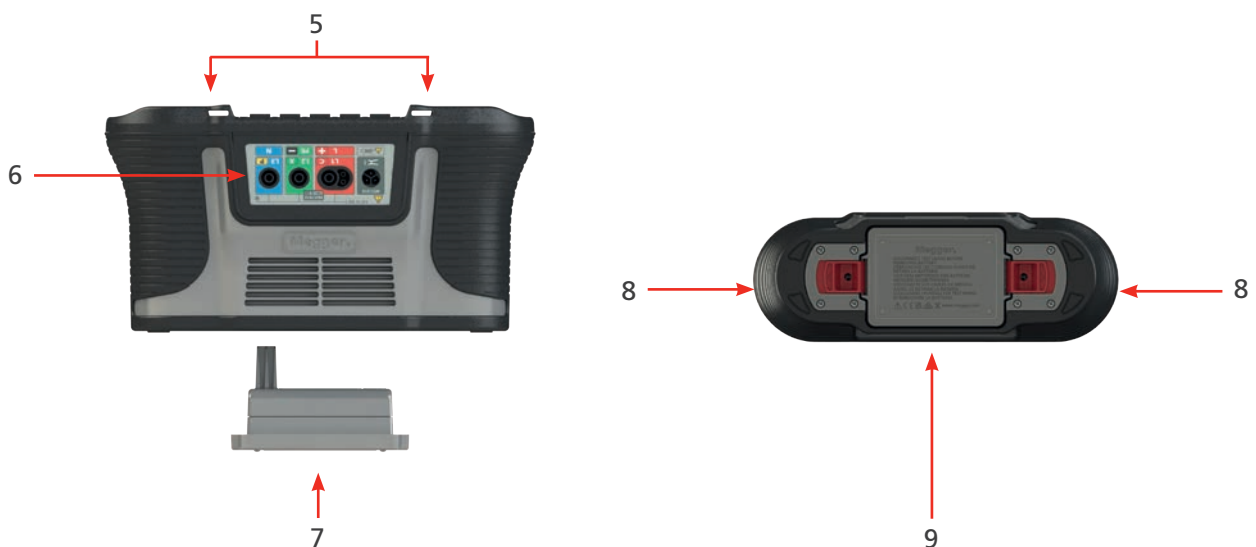

| Item | Description                         | Item | Description                    |
|------|-------------------------------------|------|--------------------------------|
| 5    | Hanging strap/neck strap attachment | 8    | Toolless battery release clips |
| 6    | Test lead connection panel          | 9    | Battery info and warnings      |
| 7    | Li-ion battery module               |      |                                |

## 4.2 Instrument display

The MFT-X1 display is a 480 x 272 colour TFT screen, with a toughened and bonded glass screen.

The display is divided into three areas:

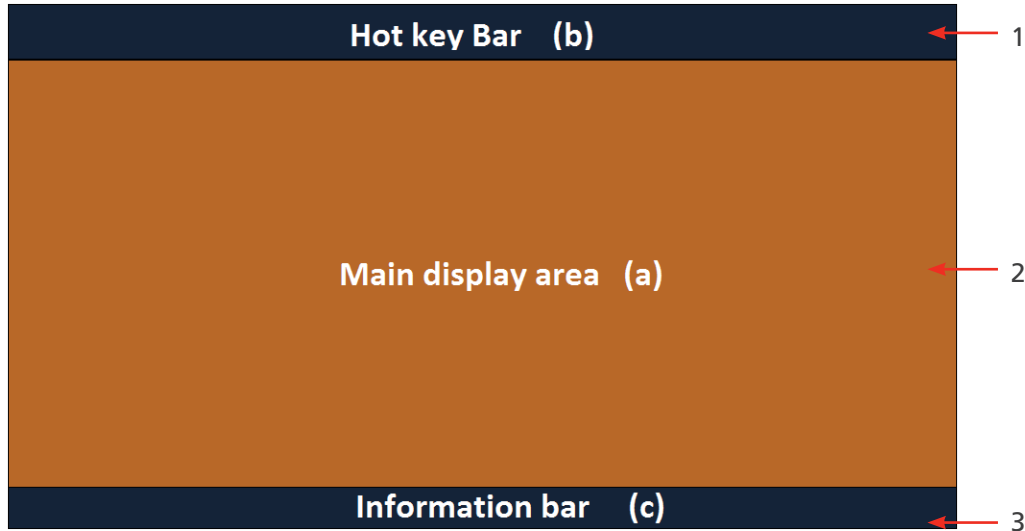

| Item | Description   | Item | Description   |
|------|---|------|---|
| 1    | Hot key bar – Shows key functions   | 3    | Information bar – shows secondary data, time date, test mode, lead connections and battery status |
| 2    | Main display area – shows all measurement quantities and secondary test information |      |   |

The purpose of the main display area is to show the measurement results. The information shown in the main display area and the way it is arranged depends on the test you are carrying out and is explained in the relevant sections for each type of test.

The display uses colour coded background for different tests, as used by Megger Limited across instrument ranges

### 4.2.1 Colour coded backgrounds

So that you can see immediately which test you have selected, even from a distance, the background colour of the main display area changes to match the test function colour code:

- Dark grey – Voltage or Current
- Orange – Continuity
- Red – Insulation
- Green – Loop impedance
- Yellow – RCD testing
- Brown – Earth testing
- Blue – Result storage
- Dark grey + cog – Setting

## 4.2.2 High contrast mode

Alternatively the display can be set to a black-on-white high contrast mode for bright sunlit environments.

Refer to 15.5.3 Contrast mode on page 84.

## 4.3 Instrument controls

The MFT-X1 has two rotary selector knobs. These allow the user to select the main measurement functions and the Hot key minor measurement functions:

- Left rotary selector – Main measurement modes
- Right rotary selector – Hot key selection options

When you turn either of the rotary knobs, the part of the main display area close to that knob shows the options you can select and which of them you have currently selected. When you stop turning the knob, this option display disappears after two seconds.

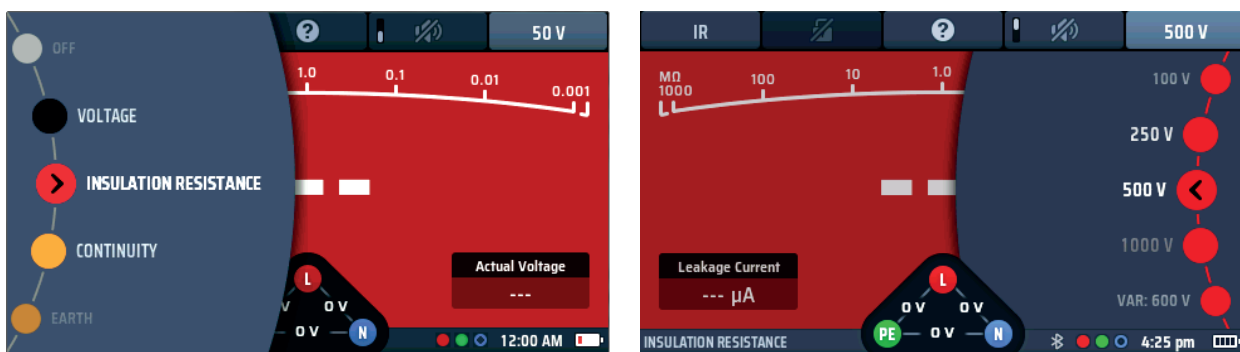

### Turning the LEFT selector wheel

Shows the options and the selected function for the main test modes  
Options never change unless instrument operating system is upgraded

### Turning the RIGHT selector wheel\* (see note below)

Shows the options and selection of the current active Hot key  
Options change depending on Hot key selected.

**NOTE :** The right selector wheel is only available where a Hot key has more than two options available, such as Insulation test voltage. Buzzer ON or OFF will not call a selector wheel.

### 4.3.1 The left-hand rotary knob

The left-hand rotary knob is used to turn the instrument off and to select the main test functions. It is also used to select the instrument set-up mode.

This knob calls the main function options in the display screen.

As the rotary knob is turned the selected function turns in the display.

The functions are colour coded to match the display colours.

### 4.3.2 The right-hand rotary knob

The right-hand rotary knob selects the secondary test options. For example, when you are measuring insulation resistance, you can use this knob to select the test voltage, as shown below:

The options you can select with the right hand knob depend on the type of test you are carrying out and on which Hot key you have pressed.

In the example above, Hot key 5 is active, allowing the range knob to show the available test voltages.

## Instrument Controls

The Hot keys only have two options. These will not have an associated rotary knob option.

The Hot key bar at the top of the screen shows the available Hot keys with an icon representing the type of function they perform.

### For example:

In continuity measurement mode the hot keys show the following:



**Fig 2:** Example of Hot keys

These functions change according to the type of test you are performing. In this case, the insulation test has four types of action:

| Hot key | Action   |
|---------|--|
| 1       | Multi-function Hot key – these have more than two options. This type of Hot key will also allow the operator to use the right range knob to access the multiple options more quickly |
| 2       | Help key – This can change to position two in Volts and Continuity. It allows access to the help screen for the test mode being run  |
| 3       | Active or not active – This can be locked or unlocked  |
| 4       | On or OFF – these usually have a switch indicator in the Hot key   |
| 5       | Option 1 or Option 2 – choose between single or bi-directional tests   |

### 4.3.3 Information bar

At the base of the screen is the information bar, as below:



**Fig 3:** Example of information bar

| Item | Description   | Item | Description    |
|------|---|------|----------------|
| 1    | Test mode selected  | 4    | Time           |
| 2    | Bluetooth® status<br>(OFF – Bluetooth® disabled):<br>(Flashing – Bluetooth® on but not connected)<br>(ON – Bluetooth® connected to mobile device) | 5    | Battery status |
| 3    | Required test-lead connections  |      |                |

**NOTE :** Test results are time stamped with the time and date. The time is displayed permanently in the INFO bar. The format can be changed. **Refer to 15.5.4 Setting the date on page 84.**

4.3.4 Test lead connection guide

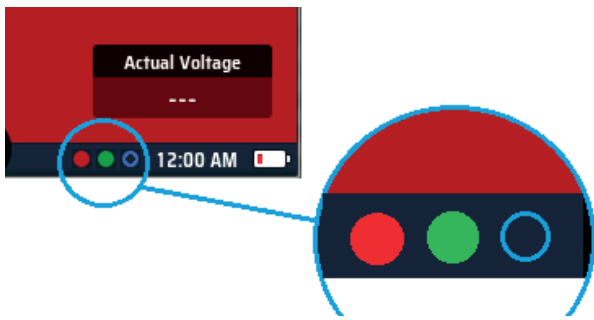

Fig 4: Connection guide

The connection guide is made up of three small circles which are colour coded to match the test-lead sockets – red, green and blue plus a grey circle for the MCC1010 current clamp. The circles show you which test-leads to plug into the sockets for the test you have selected.

If a circle is filled in with colour, a test-lead should be plugged into the socket with the corresponding colour. If the circle is shown as an open ring (not filled in with colour) no test-lead needs to be plugged into the corresponding socket. A 3rd lead connected will not affect the test mode should it be convenient to leave a 3rd lead connected.

A summary of connection options for each measurement mode is shown below:

| Continuity                     | Insulation | Earth resistance 2 pole | Earth resistance 3 pole |       | Voltage      | RCD      | Loop impedance 2 wire | Loop impedance 3 wire | Current clamp |
|--------------------------------|------------|-------------------------|-------------------------|-------|--------------|----------|-----------------------|-----------------------|---------------|
| ✓                              | ✓          |                         |                         | ● ● ○ | ✓            | ✓ (2)    | ✓ (1)                 |                       |               |
|                                |            |                         |                         | ● ○ ● | ✓            |          | ✓ (1)                 |                       |               |
|                                |            |                         |                         | ● ● ● | ✓            | ✓ (2)(3) |                       | ✓ (1)                 |               |
|                                |            | ✓                       |                         | ○ ● ● |              |          |                       |                       |               |
|                                |            |                         | ✓                       | ● ● ● |              |          |                       |                       |               |
|                                |            |                         |                         | ●     |              |          |                       |                       | ✓ (4)         |
|                                |            |                         |                         | ● ● ● |              |          |                       |                       | ✓             |
| Dead (isolated supply) testing |            |                         |                         |       | Live testing |          |                       |                       |               |

Fig 5: Terminal selection table full

1. Connection dependent on circuit being measured and type of test e.g. 2 wire or 3 wire.
2. 2 wire testing is OK for AC and A type RCDs but RDC and type B devices require three wire connection.
3. Connecting the neutral provides reverse polarity detection (also mandatory on DC RCDs and RDC).
4. Connection for MCC1010 in current mode.

### 4.3.5 Voltage widget

At the bottom centre of the screen is the voltage widget, which appears when you select any test mode except voltage or current measurement.

The widget is a triangle with a dot in each corner. The dots are coloured green, red and blue, and they correspond with the test sockets on the rear of the instrument which have the same colours.

The widget continuously shows the voltages between the test sockets, and will disappear during a live test, but appear immediately after the test has stopped.



Fig 6: Voltage widget

### 4.3.6 Terminal voltage anomalies (floating voltages)

The voltage measurement mode and the triangular voltage widget centre bottom of the display are designed to show the voltages present across the three terminals.

When all three terminals are connected to a supply they will normally show the voltage across:

- Live to Neutral
- Live to Earth
- Neutral to Earth

On a typical single phase 230 V AC supply with all three connections present you would expect to see typically:

- Live to Neutral: 230 V AC
- Live to Earth: 230 V AC
- Neutral to Earth: 0 V AC

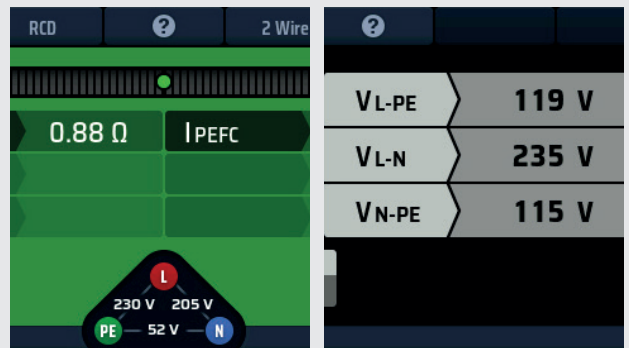

Fig 7: Floating voltages in Loop impedance and Voltage measurements

However if one of the connections is open circuit, for instance the neutral is not connected, the voltage mode or voltage widget may show an intermediate voltage, such as:

- Live to Neutral: **183 V AC**
- Live to Earth: 230 V AC
- Neutral to Earth: **53 V AC**

This happens because the instrument terminal not connected is free to float up. These intermediate voltages do not affect the performance of the instrument and will not erroneously start a test if one is present.

It is recommended that when connecting to a live supply that **all three connections are made**. This will ensure that the voltages present are representative of the connected circuit and not a floating value.

### 4.3.7 Analogue arc

When you are carrying out Continuity, Insulation Resistance or RCD ramp tests, an analogue arc appears across the top of the main bar area of the display.

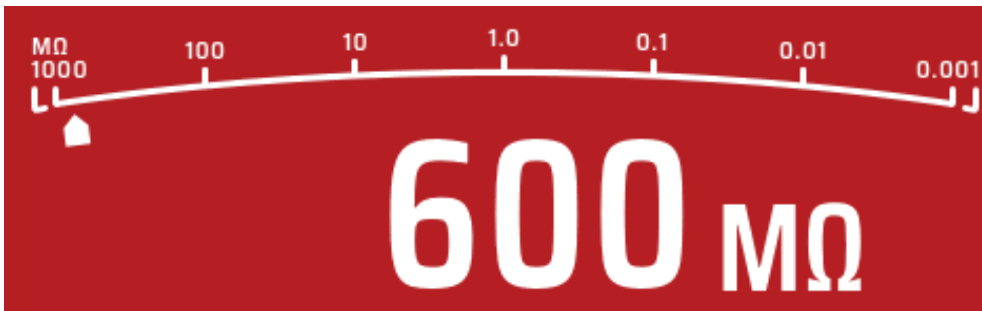

**Fig 8:** Analogue arc

All the arcs used in the instrument, with the exception of the RCD ramp test are log scale arcs. The value at each of the markers increases by a multiple of ten. This allows the arc to give good resolution at the lower values but cover a very wide measurement range without having multiple range changes.

The 'pointer' on this arc moves across the arc to give an indication of the measured value. The behavior of the pointer can provide extra information about the condition of the circuit. **Refer to 8. Insulation testing on page 34.**

## 5. Operation

This section describes how to operate the individual functions of the MFT-X1 and what each of the measurements actually do during the test sequence.

Before each use of the instrument, visually inspect the instrument case, test-leads and connectors to confirm their condition is good, with no damaged or broken insulation.

### 5.1 Switching on and off

To turn the MFT-X1 on, turn the left-hand rotary knob away from the 'OFF' position. The instrument carries out internal self-checks and, when it has successfully completed these, the display lights up.



**Fig 9:** Start up screen

To turn the MFT-X1 off, return the left-hand rotary knob to the 'off' position on the display. The display screen goes dark, confirming that the instrument is off and no longer using power from the battery.



**Fig 10:** Off screen



### 5.1.1 Auto power off (sleep function)

If you leave your MFT-X1 switched on but do not use it, the display will dim after 20 seconds, and after 5 minutes (default setting) it will automatically turn itself off to avoid wasting battery power. When this happens, you can turn it back on again by pressing any buttons. If you want to alter the time delay for the display dim or auto power off settings, or disable it entirely, you can do this in Settings. **Refer to 15.5.8 Sleep timer on page 86.**

The test buttons are located within the rotary knobs. They are coloured red and labelled 'test'. These buttons are used to start tests that require manual initiation, and for test-lead nulling (**Refer to 7.3 Test lead null on page 30.**

The way a TEST button operates a test differs from test to test. This will be either a quick press and release, such as a Loop Impedance test, or a press and hold, for insulation testing. Refer to the individual test sections below.



Both buttons have the same function and can be used in the same way.

The test button also has capacitive coupling built into the red area. This allows earth fault detection (PE Warning) to operate when the operator touches the test button during live testing.

## 5.2 Test inhibit – general inhibits

To help protect you, the instrument user, and to guard against damage to the instrument itself, the MFT-X1 inhibits testing under certain conditions. The inhibit conditions depend on the type of test you are carrying out. They are explained at the start of each relevant section.

## 6. Dead circuit tests

### 6.1 General

Whenever possible, you should use dead circuit tests (tests on circuits that are de-energized and isolated) in preference to live circuit tests. The dead circuit test functions provided by MFT-X1 series instruments are Continuity testing, Insulation Resistance measurement and Earth resistance measurement.

**WARNING : The circuit under test must be switched off, de-energized, securely isolated and proved dead before test connections are made when carrying out insulation resistance, continuity and earth resistance tests.**

### 6.2 Protection against accidental damage

MFT-X1 instruments are protected against the damage that might otherwise occur if you select a dead circuit test and connect the instrument to live circuit. The protection is effective even if you've started a live circuit test and locked it on. If you do accidentally connect to a live circuit, the instrument will warn you and inhibit or stop the test. In some circumstances, the instrument's internal fuse may fail, and you will need to replace it before you can carry out further tests. You must always use the correct type of fuse **Refer to 18.5 Fuse and fuse replacement on page 106.**

Live circuit warnings for dead circuit tests are displayed as below:

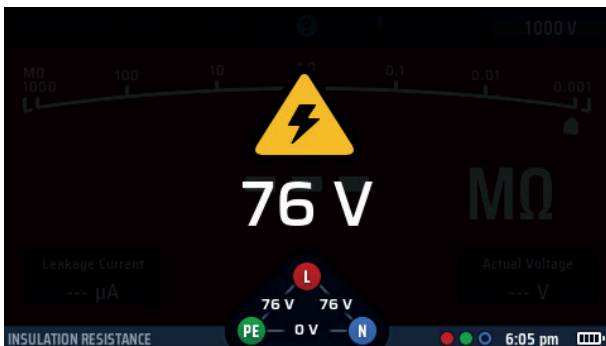

**Fig 11:** *Insulation live circuit warning*

This warning prevents the test from starting or stops a test if a hazardous voltage appears during the test.

## 7. Continuity testing and resistance measurement

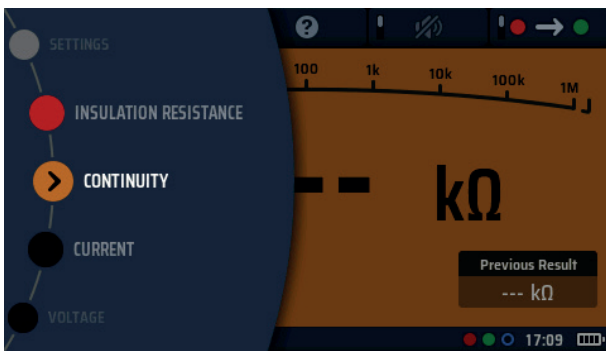

Fig 12: Continuity

### 7.1 General information

#### 7.1.1 Basic functions

**WARNING :** The circuit under test must be switched off, de-energized, securely isolated, and proved dead before test connections are made when carrying out continuity tests. Ensure that you discharge the circuit safely before touching any connections.

Instruments in the MFT-X1 range can check continuity and measure resistance from 0.01  $\Omega$  up to 999 k $\Omega$ , which means that you no longer need to use a separate meter to make resistance measurements.

A buzzer function is also provided which can speed up routine testing but, when this function is used, resistance measurements are limited to a maximum of 2.00 k $\Omega$  (or 1 k $\Omega$  on the analogue arc).

#### Analogue arc

The display also has an analogue arc, which is useful when you are investigating poor or intermittent connections. The analogue arc is a logarithmic scale, so it gives good resolution for low values of resistance but displays values up to 999 k $\Omega$  without the need to change scale (limited to 1 k $\Omega$  in buzzer mode).

#### Measurement test current and voltage

When checking the continuity of a conductor, circuit or connection, the instrument uses a default test current of 200 mA or greater, and a voltage of between 4 V to 5 V. This complies with the requirements of IEC 61557 part 4.

For circuits with higher resistance than this, the test current is reduced automatically. In all cases, the actual test current is shown at the bottom left of the main display area as highlighted below:

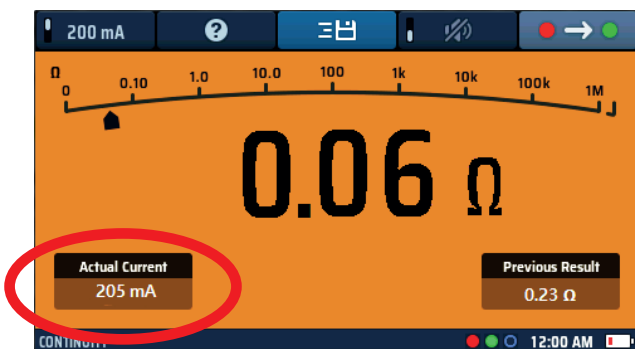

Fig 13: Continuity test current

## Continuity testing and resistance measurement

Alternatively, you can use a test current of 10 mA for continuity checking. Although this does not comply with general electrical compliance testing, it is satisfactory for routine testing, and it extends the life of the instrument's batteries. The 10 mA option is also useful when testing Neutral to Earth. This can be done on a live installation as long as suitable precautions are taken for working on live circuits, if the Neutral to Earth voltage is < 1.0 V. The 10 mA range will not generally trip 30 mA RCDs.

### 7.1.2 Test inhibit

The instrument inhibits testing if it detects a circuit voltage higher than the voltage it is applying to carry out the test. There are no disabled options for the continuity inhibit function.

The screen will display a live circuit warning if voltage is detected and make a loud, fast beeping sound.

This mode cannot be overridden and inhibits all testing until the source of the voltage is removed.

### 7.1.3 Hot keys for continuity checking and resistance measurement

When the MFT-X1 is being used to check continuity or measure resistance, the functions of the Hot keys are:



Fig 14: Continuity Hot keys

| Hot key | Function      | Description   |
|---------|---------------|---|
| 1       | Current value | Press to select 200 mA test current, press again to return to 10 mA test current  |
| 2       | Help          | Press for help on continuity checking and resistance measurement  |
| 3       | Save          | Press to send the results to a paired Bluetooth® device,<br><b>Refer to 16. Download results to a remote device on page 93.</b> |
| 4       | Buzzer On/Off | Press to turn buzzer on, press again to turn buzzer off   |
| 5       | Direction     | Press repeatedly to switch between unidirectional +ve to -ve and bi-directional modes   |

## 7.2 Continuity testing

1. Turn the left-hand rotary knob to the Continuity-position ( $\Omega$ ).
  - The display illuminates with an orange background.



2. Plug your test leads into the green and red sockets.

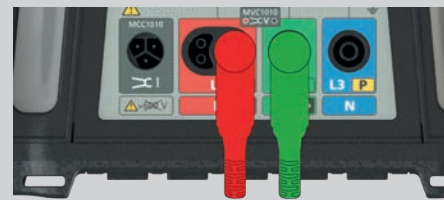

3. The default nominal test current is 200 mA. To change it to 10 mA, press Hot key 1. Press Hot key 1 again to revert to 200 mA.
  - The actual test current is shown at the bottom left of the main display area.
  - You do not need to press the test button. The test starts as soon as you connect your test leads to the circuit you are testing.



4. When the value displayed is stable, the instrument will beep.
5. The instrument shows the circuit resistance in the main display area.
  - The instrument also indicates the circuit resistance on the analogue arc in the main display area.

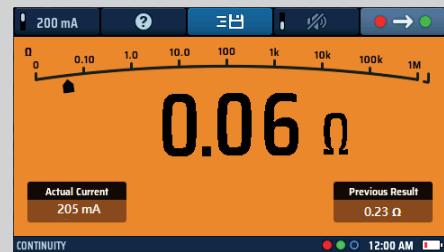

Fig 15: Continuity general

6. At the end of the test, disconnect the test leads:
  - The pointer will return to  $> 999 \text{ k}\Omega$ .
  - The actual current used during the test will remain in the lower left window.
  - The main displayed value will be transferred to the previous results window in the lower right of the display.
  - This is to ensure that a subsequent measurement is shown in the main display. If the first value was left in the main display it could be mistaken for the next measurement.



7. For help on connection of test leads to the circuit, press HELP on Hot key 2



8. To save the result or send to a mobile device, **Refer to 16. Download results to a remote device on page 93.**

## Continuity testing and resistance measurement

### 7.3 Test lead null

When checking continuity or measuring low values of resistance it is useful to make allowance for the resistance of the test-leads. This is known as nulling. If you null your test-leads, their resistance is no longer included in the value shown on the display when you make a measurement.

The null value is displayed in the lower centre of the main display area:



#### 7.3.1 To null a test lead:

1. Plug the test leads into the green and red sockets at the rear of the instrument.



2. Turn the left-hand rotary knob to the Continuity / Resistance ( $\Omega$ ) position.

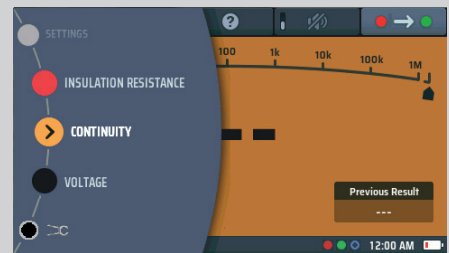

3. Short the leads together.

**NOTE :** This must be a good connection. A poor null will introduce a high null value and potentially artificially low resistances in the main measurement. Ideally use crocodile type clips or press the probe tips into a good conductor such as a copper coin.

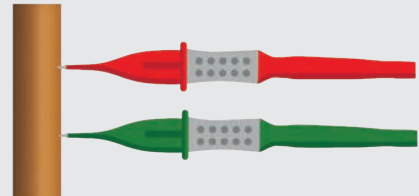

4. Press and release the test button.



- Check that the null icon appears at the bottom centre of the display. The resistance of the null value is shown below the null icon.



Fig 16: Continuity null

**NOTE :** It is a good idea to occasionally check the null value is correct, as test leads may not always give a consistent lead resistance if they are wearing out and need replacement.

### 7.3.2 To check the lead null value

1. Open circuit then short circuit the test leads a few times.
2. Ensure the main display shows 0.00  $\Omega$  each time the leads are shorted.

**NOTE :** This may vary a little depending on the quality of the contact between the test leads.

### 7.3.3 To remove a test-lead null:

1. Press the TEST button.
2. The null icon in the bottom of the display and the null value should disappear.

### 7.3.4 To update a test-lead null value

1. Remove the test lead null value.
2. Repeat the lead null process in 7.3.1 above.

### 7.3.5 Lead null errors

#### Resistance too high

Only test-leads with a resistance of 9.99  $\Omega$  or less can be nulled. If you try to null test-leads with a higher resistance, the instrument beeps and >9.99  $\Omega$  flashes on the display for three seconds.

#### Poor lead connection

If possible, use crocodile clips when shorting the leads together for nulling to ensure that you get a good connection. Alternatively, push pointed test probes firmly into a good metal conductor, such as a coin.

#### Negative lead null values

After a lead set has been nulled the main display may show values of (less than) <0.00  $\Omega$ . This is common if the leads are shorted together as the resistance may be just slightly lower than the nulled value.

It is displayed as below, and the value will flash.

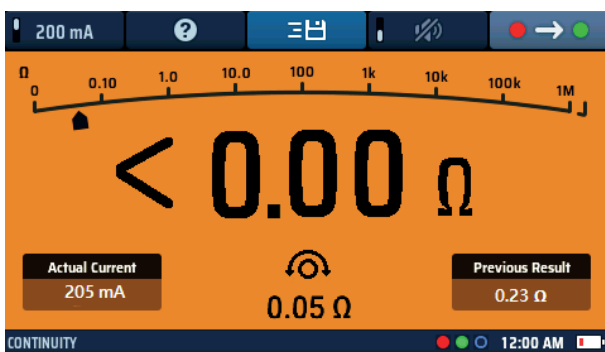

**Fig 17:** Continuity lead null too low

However, if this happens on a circuit measurement then the null value should be double checked as the null value may be significantly higher than the lead resistance. If the null value is too high the leads should be re-nulled.

#### To avoid null issues:

- Ensure there is a good connection during the nulling process. Possibly use a piece of copper pipe or bar to join the leads.
- Repeat the test-lead process as described above. Check the test-leads for signs of damage.
- Use a copper bar or piece of pipe to join the leads.

## Continuity testing and resistance measurement

### 7.3.6 Sources of errors in measurement

The results of continuity measurements can be adversely affected by:

- impedances of additional operating circuits connected in parallel
- transient currents
- a poor connection to the circuit under test
- incorrectly nulled leads
- mixing fused test leads with non-fused test leads

### 7.4 Buzzer mode up to 2 k $\Omega$ (1 k $\Omega$ on analogue scale)

The buzzer is limited to 2 k $\Omega$  of measurement range. This is deliberate as it increases the buzzer response speed. Without this limit the instrument would have to auto-range down from 999 k $\Omega$  on every test and dramatically slow the response to low resistance measurements.

To enable the buzzer:

1. Press Hot key 4 to enable buzzer
  - Press Hot key 4 again to turn it off.
2. When the buzzer is on, it sounds when the circuit resistance is less than a preset value. This is 0.5  $\Omega$  by default but can be changed in settings; **Refer to 15.6.1 Continuity buzzer threshold (limit alarm) on page 88.**
  - The preset value is displayed in the bottom of the display as shown in the example right. Here the buzzer limit has been set to 5  $\Omega$ .

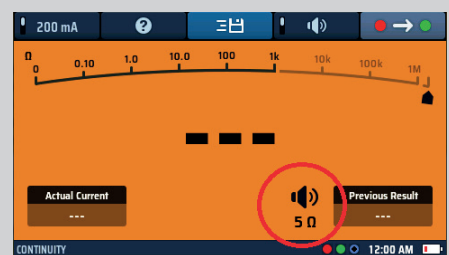

**Fig 18:** Continuity buzzer and threshold



## 7.5 Bi-directional continuity

Selecting bi-directional continuity enables an automatic continuity test to be performed with a forward test current and reversed test current without the need to reverse the test leads.

The display will show the forward polarity circuit resistance and reverse polarity of the circuit resistance. This feature may be useful where there may be a difference in conductive materials within a joint or measurement through a component such as a diode.

To change to bidirectional mode:

1. Enter continuity mode
  - Press Hot Key 5 until the symbol Image is displayed.
  - Alternatively press Hot Key 5 and use the right-hand range knob to select the bi-directional option.
2. The continuity test starts automatically the leads are connected to a circuit.
  - The display shows the values for each direction and the average of the two in the main display:
3. At the end of the test, disconnect the test leads
  - The pointer will return to  $> 1 \text{ M}\Omega$
  - The actual current used during the test will remain in the lower left window
4. The average displayed value will be transferred to the "Previous results window in the lower right of the display. This is to ensure that a subsequent measurement is shown in the main display. If the first value was left in the main display it could be mistaken for the next measurement.

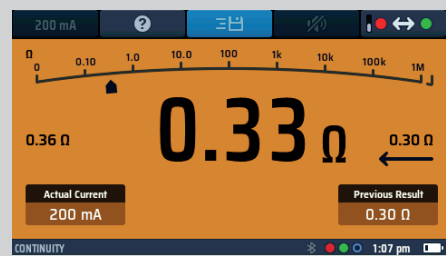

For help on connection of test leads to the circuit, press HELP on Hot Key 5.

## 8. Insulation testing

### 8.1 General

The insulation resistance test is the test specified by international standards for checking the quality of insulation between electrical conductors in an electrical installation.

The MFT-X1 can test insulation at 50 V, 100 V, 250 V, 500 V and 1,000 V. It can also test at a wide range of intermediate values using the VAR option. Most common values are:

- 500 V: Used on all new 110 V, 230 V and 400 V wiring installations
- 250 V: Used on existing installations where there is a risk of 500 V causing damage to electronic circuits

In all cases, the instrument can supply a test current of 1 mA or greater (but not more than 2 mA), which complies with the requirements of IEC 61557-2.

**WARNING :** The circuit under test must be switched off, de-energized, securely isolated, and proved dead before test connections are made when carrying out insulation tests. Ensure that you discharge the circuit safely before touching any connections.

### 8.2 Test starting timer

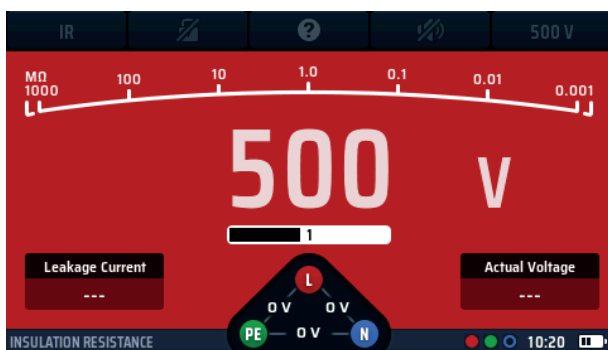

**Fig 19:** Insulation resistance (IR) start timer

All insulation tests must now have a timer to prevent them starting instantaneously. This is a mandatory requirement of IEC 61010, the international standard that defines electrical test instrument safety.

On the MFT-X1 the test voltage is turned on one second (three seconds for 1,000 V tests) after you press and hold the test button. The test remains on for as long as you keep the button pressed.

When you release the test button, the test voltage is turned off and, provided you leave the test connections in place, the circuit under test is automatically discharged.

During discharge, the display shows the residual voltage in the circuit under test in the actual voltage window. The arc will also change to volts and show the discharge of the circuit.

**NOTE :** The discharge can be very fast any may not be noticeable in the display. For capacitive circuits this can take seconds.

If the measurement has been locked on after the test has started (see Hot key 2 below) the test voltage remains on even when you release the test button. To turn the test voltage off, you must press the test button again or press Hot key 2.

**WARNING :** When the test is locked on, the circuit under test is not automatically discharged and the test-leads remain live and hazardous. The circuit can also remain hazardous once the test-leads have been removed

### 8.2.1 Insulation test-inhibit

The instrument displays a warning if it detects a circuit voltage of 25 V or higher, and it inhibits testing if the circuit voltage is 50 V or higher. You can change the inhibit voltage, but not the warning voltage, in Settings **Refer to 15.7.1 Live voltage limit on page 88.**

### 8.3 Hot keys for insulation tests

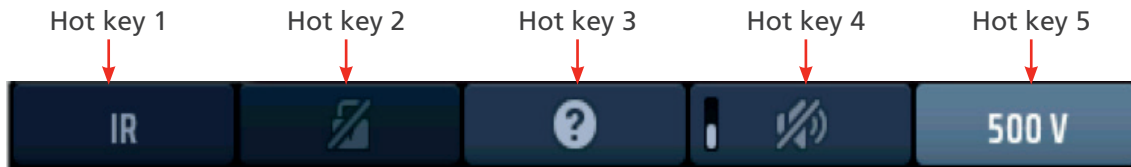

Fig 20: Insulation test Hot keys

| Hot key | Function      | Description  |
|---------|---------------|--|
| 1       |               | Not used   |
| 2       | Test lock     | Press after the test has started to lock the test on and press again to stop the test. Alternatively press the TEST button to stop the test.   |
| 3       | Help/Save     | Before starting a test, press for help on insulation testing. When the test is complete, press to transfer the result to a connected Bluetooth® device.  |
| 4       | Buzzer On/Off | Press to enable the buzzer, press again to disable the buzzer.   |
| 5       | Test voltage  | Press repeatedly to select the test voltage. Available options are 50 V, 100 V, 250 V, 500 V, 1,000 V and VAR (variable).<br><b>NOTE :</b> 1000 V is disabled from the factory but can be enabled in Settings. VAR value can be changed in Settings. |

### 8.4 All insulation tests

- The test button must be held down for the duration of the test or the lock button (Hot key 2) pressed during the test.
- For 1,000 V tests, the display flashes during the three second delay period before the test starts and a progress bar is displayed.
- When the test voltage is turned on, or the circuit under test is not fully discharged, a warning triangle is shown at the left of the display.



Fig 21: Insulation test in progress

- The leakage current flowing in the circuit under test is shown at the bottom left of the display.
- The test voltage you have selected is shown on Hot key 5. The instrument also shows the actual test voltage at the lower right of the display.
- When the instrument is discharging a circuit at the end of a test, the residual voltage is shown and the display flashes.
- If you have an insulation test selected and you connect the test-leads to a circuit carrying a voltage greater than the live voltage limit, a lightning warning symbol flashes in the display, an audible warning sounds and the voltage widget appears, as shown in fig 22 and 23.

## Insulation testing

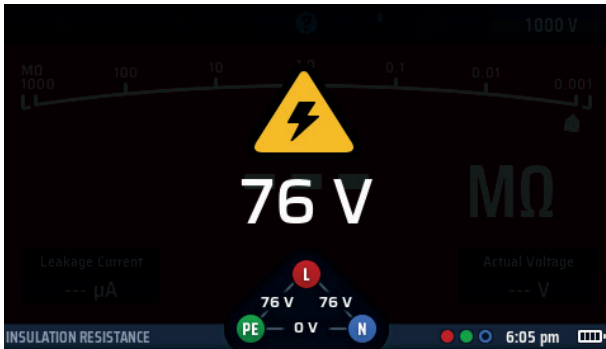
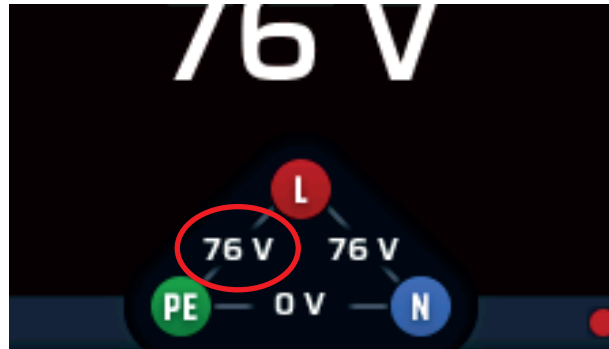

Fig 22: Live circuit warning screen



Live circuit widget

The insulation test is inhibited. The voltage widget will state where the live circuit connection is located.

- The default live voltage limit is set to 30 V, but you can change this to 50 V or 75 V in settings **Refer to 15.7.1 Live voltage limit on page 88.**

## 8.5 Insulation testing

1. Turn the left-hand rotary knob to the insulation test position (MΩ).
  - The display illuminates with a red background.



2. Plug your test leads into the red and green sockets as indicated in the INFO bar.



3. Press Hot key 5 until the test voltage you want is shown below it.
  - 3.1. Alternatively, press Hot key 5 once and use the right-hand rotary knob to select the test voltage.



4. Connect your test-leads to the circuit or asset you want to test.

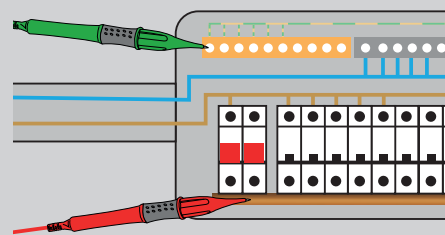

5. Press and hold the test button.
  - The test voltage is turned on after a one second delay (three seconds for 1,000 V tests).
  - The measured insulation resistance is displayed continuously.



6. Keep the TEST button pressed until the value displayed is stable.
  - The analogue arc also provides a continuous indication of the measured insulation resistance.
  - The test voltage is turned off when you release the test button.



7. After the test, do not disconnect the test-leads from the circuit or asset under test until the voltage shown on the display has fallen to a safe value.

## 8.6 Insulation test with test lock

If the lock-on function has been disabled in Settings, you will not be able to use this function.

Refer to 15.7.2 Lock button available on page 89.

|   |   |
|---|---|
| <p>1. Turn the left-hand rotary knob to the insulation test position (MΩ).</p> <ul style="list-style-type: none"> <li>The display illuminates with a red background.</li> </ul>   |     |
| <p>2. Plug your test-leads into the red and green sockets as indicated in the INFO bar.</p>   |     |
| <p>3. Press Hot key 5 until the test voltage you want is shown below it.</p> <p>3.1. Alternatively, press Hot key 5 once and use the right-hand rotary knob to select the test voltage.</p>   |     |
| <p>4. Connect your test-leads to the circuit or asset you want to test.</p>   |   |
| <p>5. Press and hold the test button.</p>   |  |
| <p>6. The test voltage is turned on after a one second delay (three seconds for 1,000 V tests).</p>   |   |
| <p>7. To lock the test on, press and release Hot key 2. You can now release the test button, and the insulation test voltage will remain on.</p> <ul style="list-style-type: none"> <li>The measured insulation resistance is displayed continuously.</li> <li>The analogue arc also provides a continuous indication of the measured insulation resistance.</li> </ul> |   |

Fig 23: Insulation test lock

## Insulation testing

8. To turn the test voltage off, either press the test button again or press Hot key 2.



### Principle of measurement

The selected DC test voltage (current limited to less than 2 mA) is applied to the circuit under test and the resistance is calculated from measurements of the resulting voltage and current. Capacitive circuits can take some time to charge, and displayed as an increasing voltage that takes longer to reach its maximum than normal. The reading is stable with a circuit capacitance less than 2  $\mu\text{F}$ .

## 9. Earth resistance measurement

**WARNING :** For the two-wire method, you will need to disconnect the earth electrode from the installation it is protecting. Before disconnecting the earth electrode, you must isolate the circuit you are working on and follow approved procedures to confirm that it is de-energized and that it cannot be accidentally re-energized. Removing the protective earth connection from a live installation is extremely hazardous!

You must also ensure that you correctly reconnect the earth electrode after completing the test.

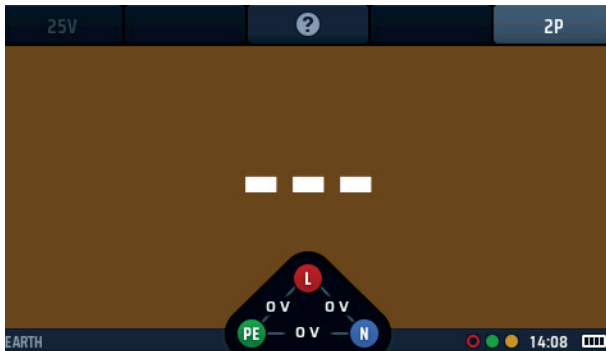

Fig 24: Earth resistance measurement

### 9.1 General

The MFT-X1 can be used to measure the resistance of earth electrodes using the following methods:

- two-pole
- three pole

The test procedure described in this user guide are suitable for use on simple earthing systems of the type typically found in domestic and small commercial installations and those associated with electric vehicle (EV) charging points. For guidance on making earth resistance measurements in complex installations, such as those that have many electrodes or use earth mats, contact the Megger technical support service.

#### 9.1.1 Terminal designations

When used for Earth testing the H,E,S terminals become C,X,P.

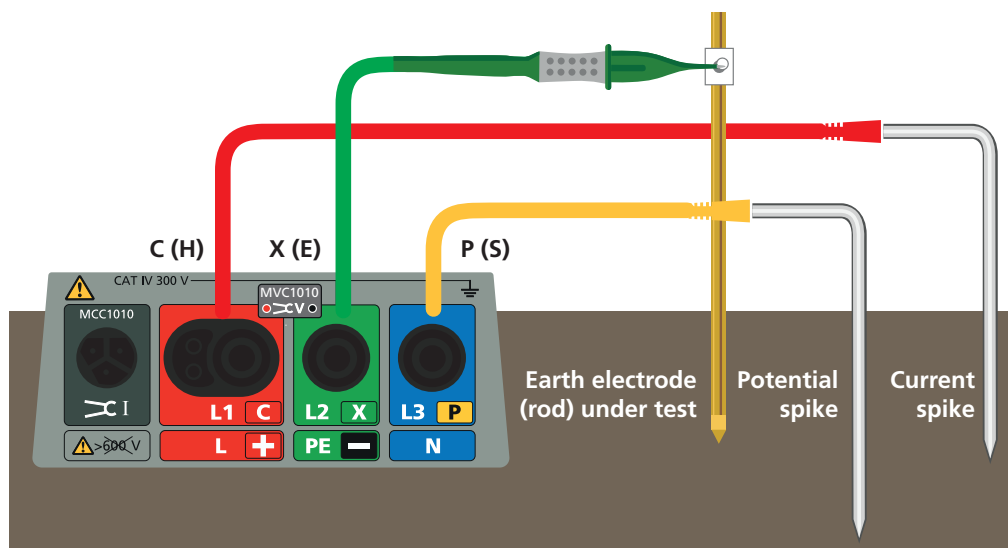

Fig 25: Earth resistance measurement terminal designations

#### 9.1.2 Earth testing inhibit

Testing is inhibited if the instrument detects an external voltage greater than 7 V RMS.

## Earth resistance measurement

### 9.1.3 Two-pole earth resistance measurements



**Fig 26:** *Earth 2P start screen*

For this type of test, the earth electrode must be disconnected from the installation or equipment it is protecting but before you do this, see the warning at the start of this section **Refer to 9. Earth resistance measurement on page 39**. This test uses one test stake which should ideally be driven into the ground 30 m away from the electrode under test, which is the maximum distance possible with the test-lead supplied. If necessary, the test stake can be positioned closer to the electrode under test, but not less than 2 m away from it. The test connections are made to the electrode under test and to the stake. This method does not deliver the most accurate results, but it is useful for confirming that the earth electrode is working correctly.

### 9.1.4 Three-pole earth resistance measurements without a current clamp

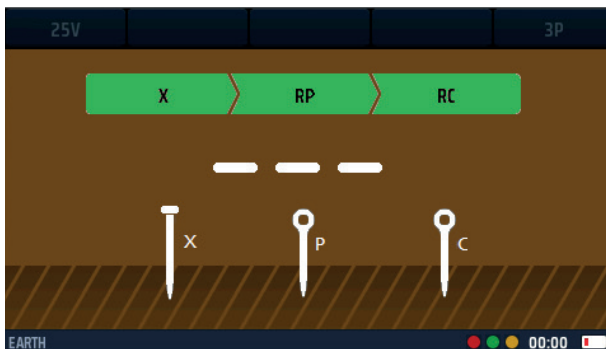

**Fig 27:** *Earth 3P*

For this type of test, the earth electrode must be disconnected from the installation or equipment it is protecting but before you do this, see the warning at the start of this section **Refer to 9. Earth resistance measurement on page 39**. This test uses two test stakes. The stakes are identical but, for convenience, one is referred to as the current stake and the other as the potential (or voltage) stake. The current stake should ideally be driven into the ground 30 m away from the electrode under test, which is the maximum distance possible with the test lead supplied. If necessary, the current stake can be positioned closer to the electrode under test but greater distance will give more accurate results. The spacing between the electrode under test and the current electrode should not be less than 2 m. The potential stake is driven into the ground half way between the electrode under test and the current stake. Test connections are made to the electrode under test and to the two stakes, then a resistance measurement is made. The measurement is repeated twice more, once with the potential stake 10% closer to the electrode under test and once with it 10% further away. The results of all three measurements should be almost the same. If they are not, it may be necessary to investigate the local ground conditions. For further advice, contact the Megger technical support service.

Three-wire earth resistance measurements are more accurate and more reliable than two-wire measurements, but they take longer to perform.



## 9.2 Hot keys for earth resistance measurement

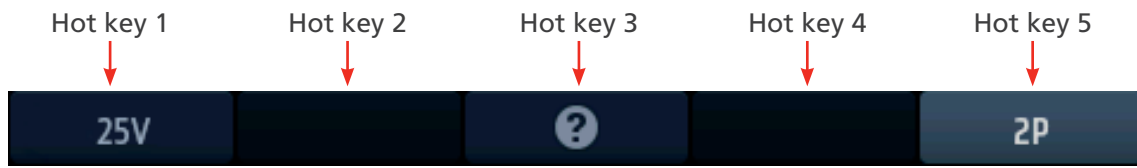

Fig 28: Earth Hot keys

| Hot key | Function     | Description  |
|---------|--------------|--|
| 1       | Test voltage | Fixed test voltage at 25 V.  |
| 2       |              | Not used.  |
| 3       | Help/Save    | Before starting a test, press for help on earth resistance measurement. When the test is complete, press to transfer the results to a connected Bluetooth® device. |
| 4       |              | Not used   |
| 5       | Test type    | Select 2P or 3P testing.   |

## 9.3 Two-pole (2P) earth resistance measurements

**WARNING :** Electrically isolate the electrical supply to the installation connected to the earth electrode you are testing. Confirm that it is isolated and that it cannot be accidentally re-energized. Only disconnect the earth electrode where it is safe to do so otherwise dangerous voltages can be created on the building earthing network.

- Turn the left-hand rotary knob to the earth test position (RE).
  - The display illuminates with a brown background.

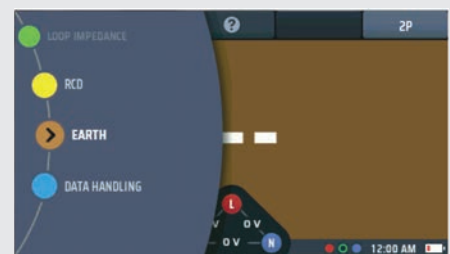

- Disconnect the earth electrode if connected.

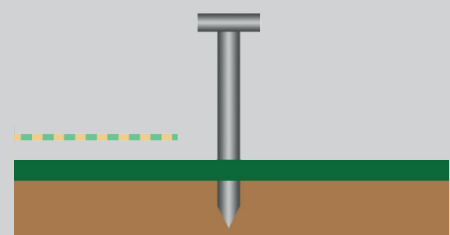

- Drive a test stake into the ground at least 2 m away from the electrode you are testing.

**NOTE :** Ideally the test stake should be as far away from the main earth spike as the test-lead will allow (up to 30 m).



- Plug a test lead into the green socket and connect it to the electrode under test.



- Plug a test lead into the yellow socket and connect it to the test stake.





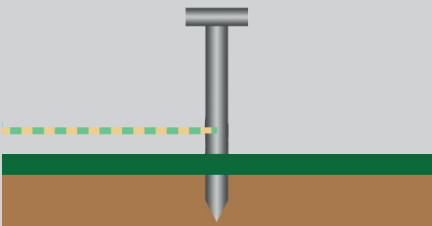



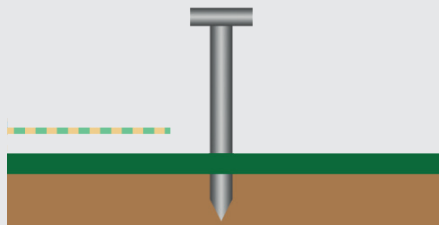
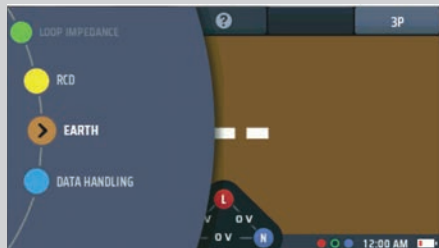

## Earth resistance measurement

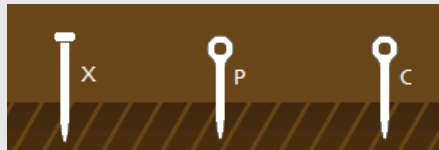
|   |   |
|---|---|
| 6. Press and release the test button.   |  |
| 7. At the end of the test, the main area of the display shows the earth resistance. |   |
| 8. Reconnect the earth electrode.   |   |

### 9.4 Three-pole (3P) earth resistance measurements without current clamp

**WARNING :** Electrically isolate the installation or equipment protected by the earth electrode you are testing. Confirm that it is isolated and that it cannot be accidentally reenergised.

|  |  |
|--|--|
| 1. Disconnect the earth electrode.   |  |
| 2. Turn the left-hand rotary knob to the earth test position (RE).<br><ul style="list-style-type: none"> <li>The display illuminates with a brown background.</li> </ul>             |  |
| 3. Press Hot key 5 repeatedly to select the three-pole (3P) test.<br>3.1. Alternatively, press Hot key 5 once and use the right-hand rotary knob to select the three-pole (3P) test. |  |
| 4. Drive a test stake into the ground as far away as possible (minimum 2 m) from the electrode you are testing. This is the current stake.   |  |
| 5. Drive another stake into the ground half way between the current stake and the electrode you are testing. This is the potential stake.  |  |

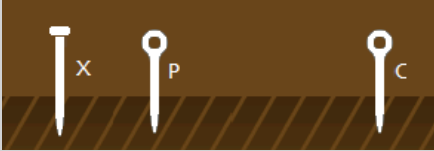
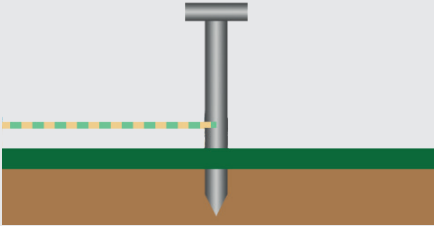
|   |  |
|---|--|
| <p>6. Plug a test lead into the green socket and connect it to the electrode under test.</p>  |    |
| <p>7. Plug a test lead into the red socket and connect it to the current stake.</p>   |    |
| <p>8. Plug a test lead into the blue socket and connect it to the potential stake.</p>  |    |
| <p>9. Press and release the test button.</p>  |   |
| <p>10. At the end of the test, the main area of the display shows the earth resistance.<br/><b>Make a note of the result.</b></p>   |   |
| <p>11. Move the potential stake 10% further away from the earth electrode than the half-way point and repeat the test.<br/><b>Make a note of the result.</b></p>  |  |
| <p>12. Move the potential stake 10% closer to the earth electrode than the half-way point and repeat the test again.<br/><b>Make a note of the result.</b></p> <ul style="list-style-type: none"> <li>▪ The three results should be almost the same.</li> <li>▪ If any of the results is significantly different, it may be necessary to investigate the ground conditions. Contact Megger technical support for advice.</li> </ul> |  |
| <p>13. Reconnect the earth electrode.</p>   |  |

## 10. Live circuit tests

### 10.1 General

Loop impedance testing requires the operator to test live electrical circuits. Connections should ideally be made when the circuit is dead (isolated). The circuit should then be made live to perform the necessary test, and once the test is complete the circuit can be isolated again to disconnect or move the test-leads.

**WARNING : When you are carrying out live circuit tests, you must observe appropriate precautions for live working.**

**WARNING : Live testing should only be performed when no other test options are available.**

**WARNING : A risk assessment should be conducted to establish if it is safe to perform live testing.**

### 10.2 Warning indication

Tests that use a live circuit or hazardous voltage during the test display a smaller warning triangle during the test. This is a reminder that hazardous live conditions exist on the circuit under test.

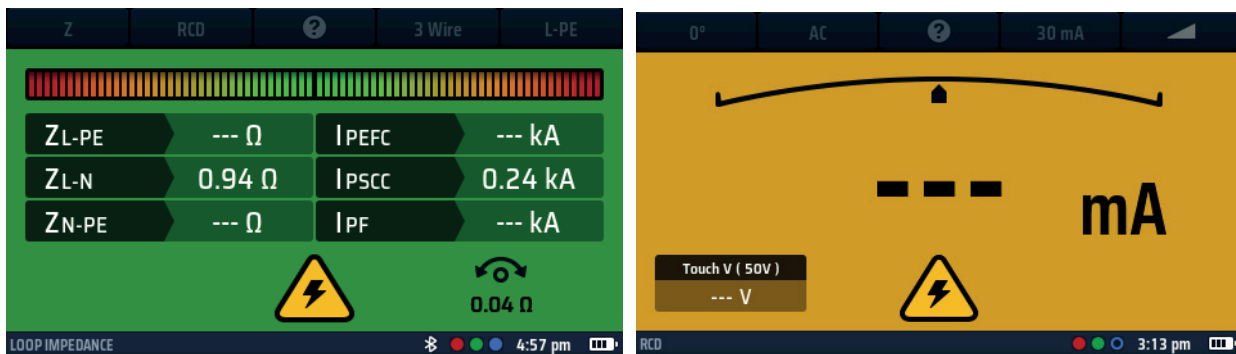

Fig 29: Live test voltage warning – Loop testing and RCD testing examples

### 10.3 Auto-start (hands-free) option

The MFT-X1 has an auto-start option for Loop impedance and RCD testing. This option is turned on for Loop testing and off for RCD testing by default but you can change these using Settings.

When enabled in settings the (hands-free) auto-start function must be primed by pressing a TEST button prior to connection to the circuit. Once primed the test will start on detection of a compliant live circuit.

The auto-start option is controlled separately for Loop and RCD testing. It is not possible to turn auto-start on for one type of RCD test and off for others. Auto-start is turned on and off in Settings. For Loop Impedance **Refer to 15.8.3 Auto start test on page 90**. For RCD tests **Refer to 15.9.3 Auto start test on page 91**.

## 10.4 Protective earth and touch voltage warnings

When you are carrying out a live circuit test (other than current measurement) and you touch the test button to start the test, the instrument automatically carries out a protective earth confirmation (PE confirmation) test.

This is not the same as the touch voltage test described in the next section.

For the PE confirmation test, if the instrument detects a protective earth fault in the PE conductor of the circuit under test, it will warn you with the following symbol in the display:

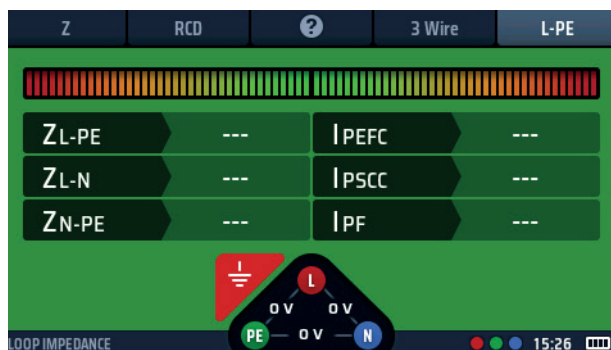

OR

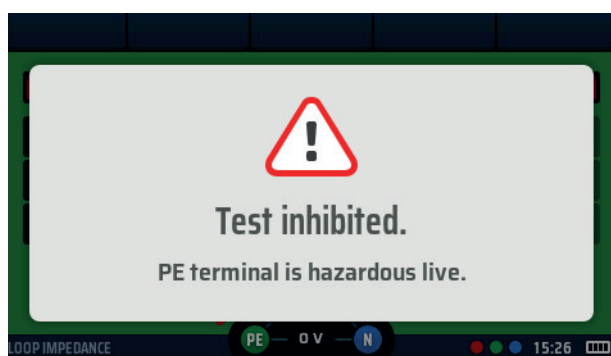

**Fig 30: PE warning blocking**

The most common cause for this error is a high resistance or missing earth connection.

### 10.4.1 Protective earth warning (PE) operation

When making a measurement on live circuits the red pad on either of the test buttons should be touched for at least 1 second to allow the PE warning detection to operate.

**NOTE :** Do not press the test button, just touch it. This is adequate for the detection circuit to identify a fault without instigating a measurement.

### 10.4.2 Inhibit protective earth confirmation (PE warning)

In some circumstances, you may need to turn off the PE confirmation test inhibit to allow testing to complete a measurement. The PE warning will still indicate the presence of a PE issue but not stop the test from operating

## 10.5 Touch voltage (fault voltage)

For both Loop Impedance and RCD testing the instrument connects a load between the live conductor and the protective earth (PE) conductor. If the PE conductor is not properly bonded to earth this will cause the voltage on it to increase, possibly to a dangerous level.

The voltage on the PE conductor is called the touch voltage or fault voltage because anyone touching parts of the installation or equipment connected to the PE conductor – typically the exposed metal parts – will experience this voltage.

If the voltage is high enough, they will receive an electric shock. To guard against this, when you start any RCD or Loop Impedance test, the instrument automatically carries out a touch-voltage check before proceeding.

The touch-voltage check takes only a fraction of a second at the start of the test and is not obvious to the operator.

In the RCD mode the result is displayed in the touch voltage area at the bottom left of the main display area.

In the Loop Impedance mode, the check is not visible, but will inhibit the main testing if hazardous.

If the check shows that the touch voltage is greater than the maximum permissible value, indicating that the protective conductor is not correctly bonded to earth, testing is inhibited.

If the touch voltage is less than the maximum permitted value, testing proceeds normally. If this voltage is high, but still below the allowed limit, it is useful to know, as it can indicate a poor earth bond that may require investigation.

The default value for the maximum permitted touch voltage is 50 V, but for special installations such as those in hospitals and where livestock may be present, this can be changed to 25 V in Settings. For Loop Impedance **Refer to 15.8.2 Maximum touch voltage on page 90**. For RCD tests **Refer to 15.9.2 Maximum touch voltage on page 91**.

You can also carry out a touch-voltage test on its own in the RCD test options. **Refer to 13.9 Touch-voltage test on page 63**.

## 11. Voltage measurement

**WARNING :** Voltage measurements are live circuit tests and all precautions for live working must be followed.

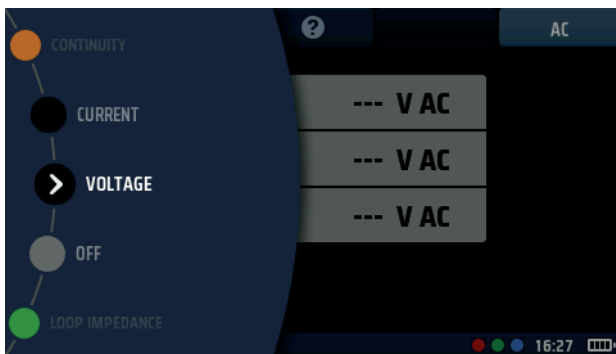

Fig 31: Voltage

### 11.1 General

The MFT-X1 can measure single and three-phase AC voltages and DC voltages. Three measuring modes are available. TRMS (true RMS) mode measures the combined value of the AC and DC voltages in a circuit.

AC mode measures only the AC voltage in the circuit and takes no account of any DC voltage that may be present.

DC measures only the DC voltage in the circuit and takes no account of any AC voltage that may be present.



Fig 32: Voltage single phase

**WARNING :** When using the MFT-X1 you should remember that if you have selected AC mode and the reading is low or zero, the circuit could still have a potentially dangerous DC voltage present. Conversely, if you have selected DC mode and the reading is low or zero, the circuit could have a potentially dangerous AC voltage present.

The MFT-X1 can also measure millivolts as below:

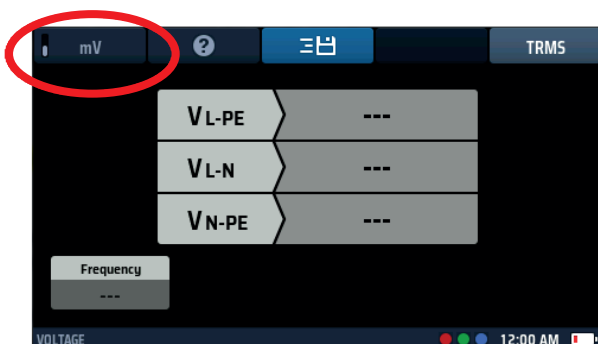

Fig 33: Voltage mV

## 11.2 Hot keys for voltage measurements



Fig 34: Voltage Hot keys

| Hot key | Function          | Description  |
|---------|-------------------|--|
| 1       | Volt/millivolt    | Press to select millivolt measurement, press again to return to normal voltage mode.   |
| 2       | Help              | Press for help on voltage measurement.   |
| 3       | Save to CertSuite | Press to send the results to a connected Bluetooth® device <b>Refer to 16.7 Sending test results to CertSuite™ on page 96.</b> |
| 4       |                   | Not used.  |
| 5       | Measurement type  | Press repeatedly to switch between TRMS, AC and DC measurements.   |

## 11.3 Display for voltage measurements



Fig 35: Voltage single phase

## 11.4 All voltage measurements

- The displayed voltage updates continuously but if you want to send your results to a connected Bluetooth® device you can do this by pressing Hot key 3.
- The default mode for voltage measurements is TRMS. To select AC-only or DC-only modes, press the Hot key 5 until the box below it on the screen shows the mode you want.
  - Alternatively, you can select the mode by pressing Hot key 5 once and using the right-hand rotary knob.
- To get help, press Hot key 2 at any time.
- The voltage widget is inhibited during voltage tests as the main bar of the display shows the voltages more accurately.

**ATTENTION :** Before and after use test a known voltage to check for correct instrument operation. Do not use the instrument if incorrect results are obtained.



## 11.5 Single-phase measurements

1. Turn the left-hand rotary knob to the Voltage position (V).
  - The display illuminates and has a black background.

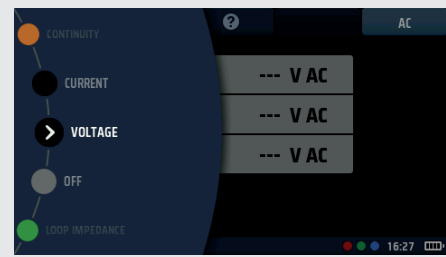

2. For a two-wire test, plug your test-leads into the green and red sockets as indicated in the INFO bar.

- 2.1. For a three-wire test or if you are using a mains plug lead, plug the green protective earth (PE) test-lead into the green socket, red live (L) test-lead into the red socket, the blue neutral (N) test-lead into the blue socket.



3. Connect the green (PE) test-lead, to the Earth conductor, the red (L) test-lead to the Live conductor and the blue test-lead to the neutral conductor of the circuit to be measured.

**You do not need to press the test button.**

The test is running continuously and is constantly displaying the voltages on the test terminals.

4. For two-wire tests, the instrument displays a single voltage.
  - 4.1. For three-wire tests, the live-to-PE, live-to-neutral and neutral-to-PE voltages are displayed simultaneously.



## 11.6 Three-phase measurements

- Turn the left-hand rotary knob to the Voltage position (V).
  - The display illuminates and has a black background.

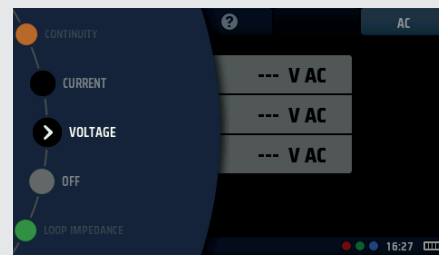

- Plug the test leads into the red (L1), green (L2) and blue (L3) sockets.



- Connect the red test-lead to the L1 conductor, the green test-lead to the L2 conductor and the blue test-lead to the L3 conductor of the circuit to be measured.

**You do not need to press the test button.**

The test is running continuously and is constantly displaying the voltages on the test terminals.

- The instrument displays the L1-to-L2, L2-to-L3 and L1-to-L3 voltages simultaneously.

The instrument also displays the supply frequency.

The instrument also displays the phase sequence of the supply, as below.



## 11.7 Phase sequence

- When measuring three-phase voltages, the instrument automatically shows phase sequence.



**Fig 36: Voltage phase rotation**

- Normal phase sequence is shown as 1-2-3. Reverse phase sequence is shown as 3-2-1.

If the instrument is set to DC mode and phase rotation is detected, it automatically switches to TRMS mode and the display area below Hot key 5 flashes five times to alert the user.



**Fig 37: Hot key 3**

## 11.8 Millivolt measurements

1. Turn the left-hand rotary knob to the Voltage position (V).  
The display illuminates and has a black background.

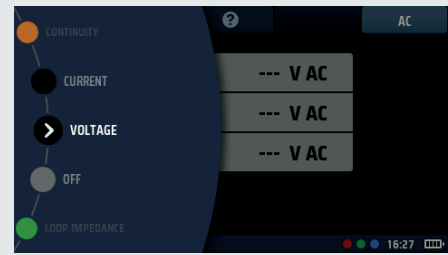

2. Press Hot key 1 until the box below it shows mV.



3. Plug the test leads into the red and green sockets.



4. Connect the red test-lead to the positive potential conductor, the green test-lead to the negative potential conductor of the circuit to be measured.

**You do not need to press the test button.**

The test starts as soon as you connect your test-leads to the circuit you are testing.

5. The instrument displays a single voltage in millivolts up to a limit of 1999 mV.

**NOTE :** The mV option is only available across the red and green terminals of the instrument.



## 11.9 Frequency measurement

- When making AC or TRMS measurements, the instrument automatically shows the supply frequency in the bottom left of the display.
- The frequency display is inhibited when DC voltages is selected.

## 11.10 Sending results to a Bluetooth® device

- Press Hot key 3 at any time to send the results shown in the main area of the display to a connected Bluetooth® device such as a tablet or smartphone



**Fig 38:** Hot key 3

- For information about connecting mobile devices with the MFT-X1, **Refer to 16. Download results to a remote device on page 93.**

## 12. Current measurement

**WARNING :** Current measurements are live circuit tests and all precautions for live working must be followed.

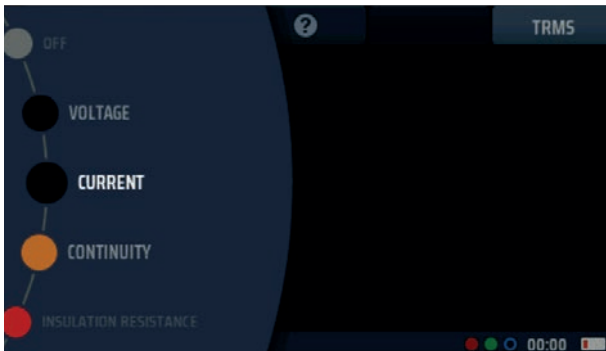

Fig 39: Current measurement

### 12.1 General

When used with an optional MCC1010 current clamp, the MFT-X1 can measure AC and TRMS currents.

### 12.2 Hot keys for current measurements

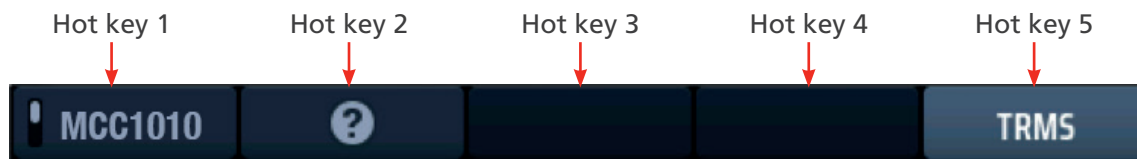
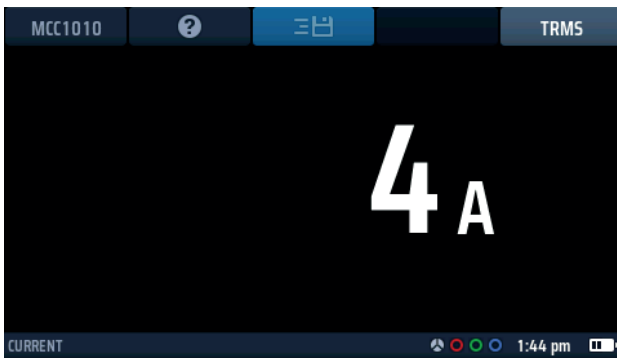

Fig 40: Current Hot keys

| Hot key | Function         | Description   |
|---------|------------------|---|
| 1       | Clamp setting    | This setting currently only offers the MCC1010 clamp.   |
| 2       | Help             | Press for help on current measurement.  |
| 3       | Save             | Press to send the results to a connected Bluetooth® device, <b>Refer to 16. Download results to a remote device on page 93.</b> |
| 4       |                  | Not used.   |
| 5       | Measurement type | Press repeatedly to switch between AC and TRMS measurements.  |

## 12.3 All current measurements

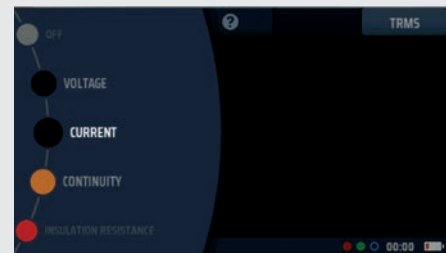

**Fig 41:** Current clamp initial screen with MCC1010 connected

- The voltage display updates continuously but if you want to send your results to a connected Bluetooth® device you can do this by pressing Hot key 3.
- To get help, press Hot key 2 at any time.

## 12.4 Current measurements

1. Turn the left-hand rotary knob to the position marked CURRENT.
  - The display illuminates and has a black background.



2. Using a Megger MCC1010 clamp, plug it into the grey 3 pin socket.
  - The display illuminates and has a black background.

**NOTE :** This is a polarized connection. Do not force the plug into the socket.



3. Position your clamp around the cable carrying the current you want to measure.

In the examples shown here the clamp connection can be made around a single conductor, or around two conductors.

The clamp around the two conductors will indicate the difference between the two conductor currents. This is referred to as a differential measurement

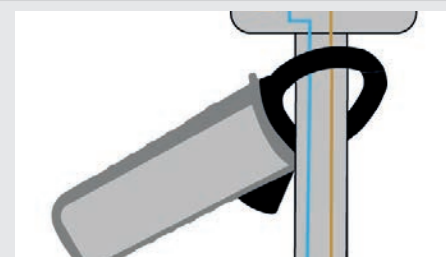

4. You do not need to press the test button. The test starts automatically as soon as you have positioned the clamp.

## 13. Residual current device (RCD) testing

**WARNING : RCD tests are live circuit tests and all precautions for live working must be followed.**

### 13.1 General

The MFT-X1 can measure the tripping time and tripping current for a wide range of residual current device (RCD) and Residual Direct Current-Disconnection Device (RDC-DD) types with sensitivity from 10 mA to 1000 mA. RDC-DD is shortened to RDC in the MFT-X1.

Tests carried out by the instrument comply with IEC 61557 Part 6 for RCDs and IEC 62955 for RDC-DDs

Test options include trip time testing, trip current testing and combined or separate touch voltage testing, also referred to as fault voltage testing.

The instrument also offers a unique user-configurable automatic test sequence that includes some or all these tests, as well as ramp tests that are useful for investigating nuisance tripping.

#### 13.1.1 Types of RCD supported

The MFT-X1 can test these types of RCD:

- AC – ensures disconnection for AC residual currents only
- A – ensures disconnection for AC and pulsed DC residual currents
- F – should be tested as type A, but is sensitive to higher frequency earth faults
- B – ensures disconnection for AC, pulsed DC and smooth DC residual currents
- EV (RDC-DD) – ensures disconnection for pure DC residual currents of up to 10 seconds duration
- (S) – Delayed versions of RCDs

**NOTE :** An RDC is a Residual Direct Current detecting device found in EV charger systems that typically operates at less than 6 mA DC in a time of not greater than 10 seconds.

**NOTE :** A type S version of an RCD have a delayed trip on detection of a leakage current. This is intended for use where there is a requirement for discrimination between RCDs in a protection installation. Testing a type S version starts a 30 second count-down timer before applying the tripping tests. This is required to ensure the internal delay is not compromised by the touch voltage test at the start of all RCD tests. This touch voltage test is not visible to the user but could affect the delay enough to create a faster trip time than normal, potentially failing the RCD.

**NOTE :** RCBOs (residual current breakers with overcurrent protection) can be tested in the same way as RCDs, but only the residual current protection function provided by these devices is tested, not the over-current protection.

#### 13.1.2 RCD test current

When testing RCDs or an RDC, you should select the test current that matches the nominal rating of the device under test. For example, for a 30 mA RCD, select a test current of 30 mA on the instrument followed by the multiplier you need, e.g. 1/2 x I, 1 x I, 2 x I or 5 x I.

The MFT-X1 has a limit of 1000 mA for any test selected. With some higher current RCDs and especially type A or type B RCD, the range of tests that you can carry out is restricted. For example, the MFT-X1 cannot perform 5 x I tests on RCDs with a 300 mA rating or higher, as this would require a test current of 5 x I or 5 x 300 mA = 1500 mA, exceeding the 1000 mA limit. The diagram below shows which combinations of RCD type and test current are supported, and which are not. If you try to select an unsupported combination, this diagram is shown automatically on the instrument display as a reminder.

RCD Types: AC, AC-S OK

| RCD Rated Current | 10 mA | 30 mA | 50 mA | 100 mA | 300 mA | 500 mA | 650 mA | 1000 mA | Max VAR Current |
|-------------------|-------|-------|-------|--------|--------|--------|--------|---------|-----------------|
| 1/2I, 1I, Ramp    | ✓     | ✓     | ✓     | ✓      | ✓      | ✓      | ✓      | ✓       | 1000 mA         |
| 2I                | ✓     | ✓     | ✓     | ✓      | ✓      | ✗      | ✗      | ✗       | 500 mA          |
| 5I                | ✓     | ✓     | ✓     | ✓      | ✗      | ✗      | ✗      | ✗       | 200 mA          |

■ Available      ■ Not available

Fig 42: Diagram of permitted test/type/rating combinations

13.1.3 About the RCD tests

For all the tests, the instrument causes a current to flow between line and earth on the load side of the circuit protected by the RCD under test. This simulates the effect of an earth leakage fault. When such a fault occurs, the earth leakage current creates an imbalance between the currents in the live and neutral conductors that pass through the sense coils (A) and (B) of the RCD. That is, some of the line current returns via the earth path, not the neutral. When this imbalance is greater than the sensitivity (rating) of the RCD, the RCD trips and disconnects the circuit it is protecting.

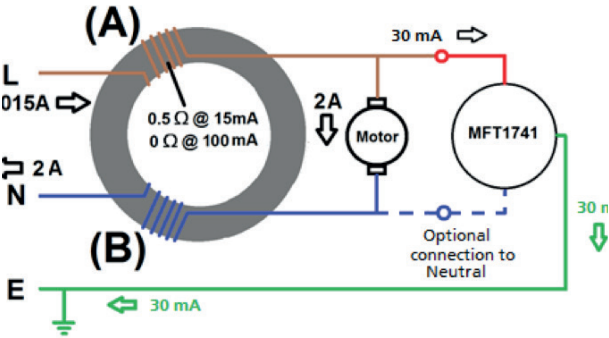

Fig 43: Simplified RCD circuit

13.1.4 The 1/2 x I test

For this test, the instrument uses a current equal to half the rating (1/2 x I) of the RCD under test. This current is applied for 2 seconds, and the RCD should not trip during this time. If the RCD test is completed successfully, the display shows >1999 ms. If needed the maximum test time can be changed to 500 ms in Settings, **Refer to 15.9.5 Maximum test time 1/2 x I on page 92**. If the breaker trips during the test, which may indicate that it is too sensitive, the test stops, and the display shows the actual trip time.

13.1.5 The 1 x I test

For this test, the instrument uses a current equal to the nominal rating (1 x I) of the RCD under test. The RCD should trip within 300 ms for devices that comply with IEC 61008/9, and within 200 ms for older devices that comply with old British Standards such as BS7288. When the RCD trips the test stops and the instrument shows the actual trip time. If the RCD fails to trip, the test stops after 300 ms and shows >300 ms or >200 ms depending on the instrument settings. You can change the test time in Settings, **Refer to 15.9.6 Maximum test time 1 x I on page 92**.

13.1.6 The 2 x I test

For this test, the instrument uses a current equal to twice the rating (2 x I) of the RCD under test. The RCD should trip within 150 ms. When the RCD trips the test stops and the instrument shows the actual trip time. If the RCD fails to trip, the test stops after 150 ms, and the display shows >150 ms.

## Residual current device (RCD) testing

### 13.1.7 The 5 x I test

For this test, the instrument uses a current equal to five times the nominal rating ( $5 \times I$ ) of the RCD under test. The RCD should trip within 40 ms. When the RCD trips the test stops and the instrument shows the actual trip time. If the RCD fails to trip, the test stops after 40 ms, and the display shows >40 ms.

### 13.1.8 The ramp test

This test is not usually included in the national and international standards for RCD testing, but it is useful for investigating 'nuisance tripping', where the RCD sometimes trips for no obvious reason. For the ramp test, the instrument initially applies a test current equal to half of the rating of the RCD (or less) then steadily increases this current up to a maximum of 1.1 times (110%) the rating of the RCD. During the test, the current is shown as a percentage on an analogue arc in the main area of the display. If the breaker trips during the test, the current at which it tripped is shown in the main area of the display. If the breaker does not trip, the test stops when the current reaches 110%, the pointer on the analogue arc stops at 110%, and the main display shows greater than a value equal to  $1.1 \times$  the rating of the RCD. For example, if you are testing a 30 mA RCD and it fails to trip, at the end of the test the main display will show >33 mA.

### 13.1.9 Testing at 0° and 180°

All the RCD and RDC tests can be carried out at either 0° or 180°. If you select the 0° option, the test starts when the load current is going positive and if you select the 180° option the test starts when load current is going negative. Some RCDs may give different results at 0° and 180° so it is advisable to perform both options. If you have selected automatic testing, the instrument automatically repeats the tests at 0° and 180°, unless this feature has been turned off in Settings, **Refer to 15.9.7 Auto sequence customisation on page 92.**

**NOTE :** For Type A and B RCDs and RDCs the correct terms would be positive (+ve) and (-ve). However for simplicity the display shows 0° and 180°. RCD tests with pulsed DC and smooth DC test currents need to be performed using both polarities.

### 13.1.10 RCD testing inhibit

The instrument inhibits testing if the touch voltage is, or is predicted to be, higher than 50 V.

Testing is also inhibited if the supply voltage is outside the acceptable range (45 V AC to 280 V AC for nominal 230 V supplies and 376 V AC to 550 V AC for nominal 400 V AC supplies), or if the supply frequency is outside the acceptable frequency range (45 Hz to 65 Hz for nominal 50 Hz supplies).

### 13.1.11 Sources of error in measurements

RCD test results can be affected if loads, particularly rotating machinery and capacitive loads, are left connected during tests. Special conditions in residual current devices (RCD) of a particular design, for example of type S (selective and resistant to impulse currents) need to be taken into consideration.



## 13.2 Hot keys for RCD tests

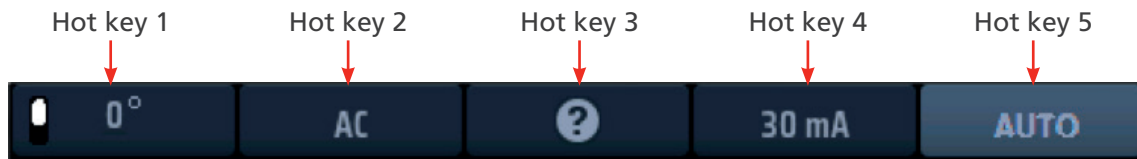

Fig 44: RCD Hot keys

| Hot key | Function     | Description   |
|---------|--------------|---|
| 1       | 0°/180°/AUTO | Press to select 180° testing, press again to select 0° testing. This Hot key is disabled if the test type selected is "AUTO".   |
| 2       | RCD type     | Press repeatedly to select the type of RCD you are testing. Available options are: AC, AC(S), A, A(S), B, B(S), EV A/B, EV A/RDC  |
| 3       | Help/Save    | Before starting a test, press for help on RCD testing. When the test is complete, press to send the results to a connected Bluetooth® device, <b>Refer to 16. Download results to a remote device on page 93.</b>     |
| 4       | Current      | Press repeatedly to select the current rating of the RCD you are testing. Available options are: 10 mA, 30 mA, 100 mA, 300 mA, 500 mA, 650 mA, 1000 mA, VAR.  |
| 5       | Test type    | Press repeatedly to select the test type. Available options are: AUTO, ½ x I, 1 x I, 2 x I, 5 x I, RAMP, Touch V.<br><b>NOTE</b> : Selecting EV A/B or EV A/RDC on Hot key 2 will limit Hot key 5 option to AUTO only |

## 13.3 Display layout for RCD tests (AUTO TEST example shown)



Fig 45: RCD auto test example start screen

## 13.4 Touch voltage – All RCD, RDC and touch voltage tests

- A touch-voltage test is automatically carried out before any of the RCD or RDC tests start. For a stand-alone touch-voltage test **Refer to 13.9 Touch-voltage test on page 63.**
- If you use a three-wire connection to the circuit under test and the instrument detects that the live and neutral connections are reversed, it displays a warning and inhibits the test. The test inhibit but not the warning, can be disabled in Settings, **Refer to 15.9.1 Allow reverse polarity on page 91.**
- While the instrument is carrying out a test, all the Hot keys are disabled.
- To test RCDs with a current rating that does not match any of the presets that the instrument offers, you can use the VAR option, **Refer to 13.10 VAR (Variable RCD) on page 64.**

### 13.5 Automatic RCD testing

#### Residual current device (RCD) testing

1. Turn the left-hand rotary knob to the RCD test position (RCD).
  - The display illuminates with a yellow background.

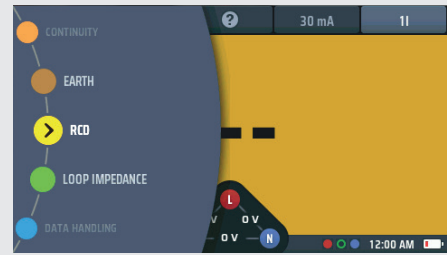

2. For Type AC and A RCDs you can use two-wire testing. Plug your L (red) test-lead into the red socket and your PE (green) test-lead into the green socket.
  - 2.1. For type B and EV RCDs/RDCs you need three-wire testing. Plug your L (red) test-lead into the red socket, your PE (green) test-lead into the green socket and your N (blue) test-lead into the blue socket.



or for type B or EV use 3 leads



**Three-wire is necessary for type B RCDs and EV/RDC.**

3. Repeatedly press Hot key 2 until the type of RCD you are testing is shown.
  - 3.1. Alternatively, press Hot key 2 once and use the right-hand rotary knob to select the type of RCD you are testing.
4. Repeatedly press Hot key 4 until the current rating of the RCD you are testing is shown.
  - 4.1. Alternatively, press Hot key 4 once and use the right-hand rotary knob to select the current rating of the RCD you are testing from the list of options.



5. Repeatedly press Hot key 5 until the Hot key 5 displays AUTO.
  - 5.1. Alternatively, press Hot key 5 once and use the right-hand rotary knob to select AUTO from the options.



6. Connect your test-leads to the circuit on the load side of the RCD you want to test.

**NOTE :** For reverse polarity detection use 3 wire connections for all types of RCD or RDC testing.

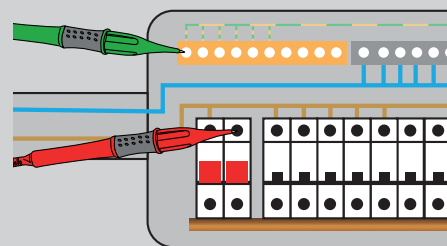

7. Press and release the test button
  - The instrument will start the test sequence with the non-trip testing and start to complete the AUTO sequence table of results.



8. Once the tripping test commence, the RCD will need to be reset for the sequence to continue.

**NOTE :** The tests will automatically start when the RCD is reset.

9. As each test in the sequence is completed, the result for that test is added to the display. The testing progress is very clear in the table of results.
10. When the whole test sequence is completed, the display shows all the results.
11. The voltage widget at the base of the display will show 0V if the RCD was not reset after the final trip. Resetting the RCD will show the supply voltage in the voltage widget.

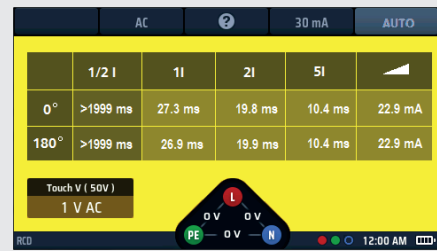

Fig 46: AUTO RCD test result progress

**NOTE :** Connection can be made at the end of the circuit, in the distribution board or on the RCD

**NOTE :** Some RCBOs will not trip if tested by connecting directly onto the screw terminals of the RCBO.

If the RCD does not trip the display shows:

- >1999 ms (or >500 ms)\* for the ½ x I test. This indicates the RCD has passed the test.
  - >300 ms for the 1 x I test. This indicates the RCD has failed the test by not tripping or tripping too late
  - >150 ms for the 2 x I test. This indicates the RCD has failed the test by not tripping or tripping too late
  - >40 ms for the 5 x I test. This indicates the RCD has failed the test by not tripping or tripping too late
- Note: Connection can be made at the end of the circuit, in the distribution board or on the RCD

\* >1999 ms or >500 ms options can be set in Settings.

This value will depend on the standard to which the RCD is being tested

### 13.5.1 Customising the AUTO test sequence

The default AUTO test sequence is ½ x I, 1 x I, 2 x I, 5 x I and RAMP with all tests repeated at 0° and 180°. You can customize the sequence in Settings. You can remove any of the tests you don't need in your AUTO sequence (if you leave at least one test) and you can disable testing at 0° or 180°, but not both. For details of how to customize the AUTO test sequence, **Refer to 15.9.7 Auto sequence customisation on page 92..**

## 13.6 RCD testing at a single current

1. Turn the left-hand rotary knob to the RCD test position (RCD).
  - The display illuminates with a yellow background.

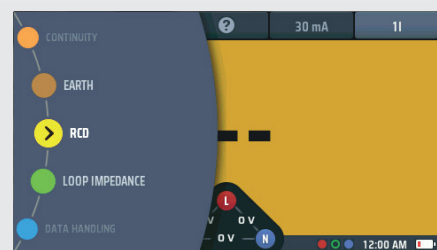

2. Connect the test leads.

- 2.1. For Type AC and A RCDs you can use two-wire testing. Plug your L (red) test-lead into the red socket and your PE (green) test-lead into the green socket.
- 2.2. For type B and EV RCDs/RDCs you need three-wire testing. Plug your L (red) test-lead into the red socket, your PE (green) test-lead into the green socket and your N (blue) test-lead into the blue socket.



or for type B or EV modes use 3 leads



**Three-wire is necessary for type B RCDs and EV/RDC.**

## Residual current device (RCD) testing

3. Press Hot key 1 to select either a 0° or a 180° test.



4. Repeatedly press Hot key 2 until the type of RCD you are testing is shown.

4.1. Alternatively, press Hot key 2 once and use the right-hand rotary knob to select the type of RCD you are testing.



5. Repeatedly press Hot key 4 until the current rating of the RCD you are testing is shown.

5.1. Alternatively, press Hot key 4 once and use the right-hand rotary knob to select the current rating of the RCD you are testing as shown on the right.



6. Repeatedly press Hot key 5 until the test current option you want is shown.

Available options are 1/2 x I, 1 x I, 2 x I and 5 x I.

6.1. Alternatively, press Hot key 5 once and use the right-hand rotary knob to select the current option.



7. Connect your test-leads to the circuit on the load side of the RCD you want to test.

Use a three-wire connection if you want the instrument to warn you of reversed L and N.

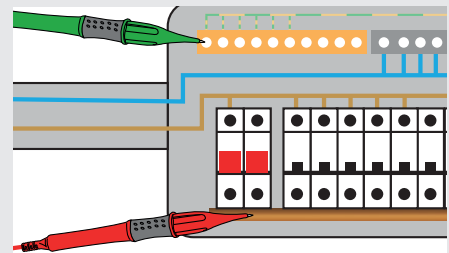

8. Press and release the test button.

**NOTE :** If the auto-start option is enabled the TEST button can be pressed before connection of the test-leads. When the instrument detects the live circuit the test will start. **Refer to 15.9.3 Auto start test on page 91.**



9. At the end of the test, the main area of the display shows the trip times for the test.

The display also shows the touch voltage calculated for the 1 x I current.



■ If the RCD does not trip the display shows:

- >1999 ms or >500 ms for the 1/2 x I test. This indicates the RCD has passed the test.
- >300 ms for the 1 x I test. This indicates the RCD has failed the test by not tripping or tripping too late.
- >150 ms for the 2 x I test. This indicates the RCD has failed the test by not tripping or tripping too late.
- >40 ms for the 5 x I test. This indicates the RCD has failed the test by not tripping or tripping too late.

**NOTE :** Connection can be made at the end of the circuit, in the distribution board or on the RCD.

**NOTE :** Some RCBOs will not trip if tested by connecting directly onto the screw terminals of the RCBO. They should be tested from further down-stream, either in the distribution board or at a local socket.

### 13.7 3 Phase RCD testing

The MFT-X1 is designed to test RCDs on 3 phase installations.

To test RCDs in a 3 phase system each RCD is tested as a single RCD, from Phase to earth. As described in **Refer to 13.1.2 RCD test current on page 54.** to **Refer to 13.1.7 The 5 x I test on page 56.**

Where no earth is available, the upstream/downstream method can be used. This requires testing across two phases, as below.

1. To test Phase 1 RCD, connect the MFT Red (L1) terminal to the downstream (o/p) of the RCD to be tested.
2. Connect the Green (L2) terminal of the MFT to the upstream phase of an RCD on a separate phase.
3. Press the TEST button.
4. The MFT will display the trip time of the RCD.

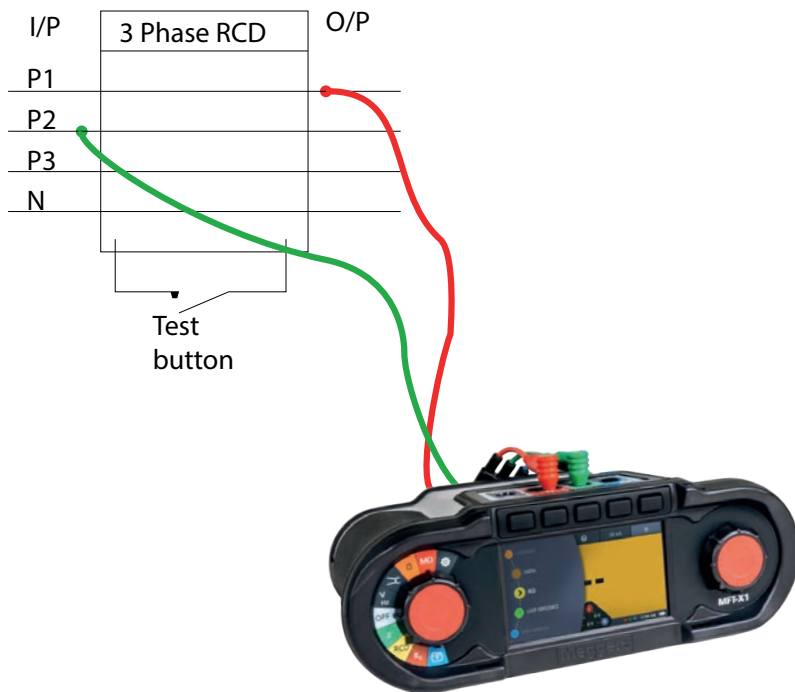

### 13.8 Ramp testing RCDs

**NOTE :** Separate ramp testing is not currently available for EV modes. A single ramp test can be isolated in the AUTO sequence settings in Settings by removing the 1/2 x I, 1 x I 2 x I and 5 x I options.

1. Turn the left-hand rotary knob to the RCD test position (RCD).
  - The display illuminates with a yellow background.

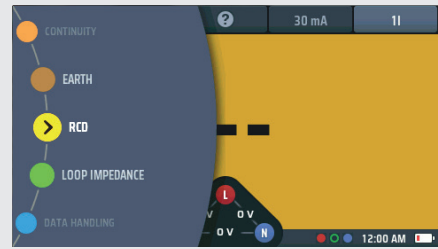

2. For Type AC and A RCD you can use two-wire testing. Plug your L (red) test-lead into the red socket and your PE (green) test-lead into the green socket.
  - 2.1. For type B and EV RCDs/RDCs you need three-wire testing. Plug your L (red) test-lead into the red socket, your PE (green) test-lead into the green socket and your N (blue) test-lead into the blue socket.





or for type B or EV modes use 3 leads



**Three-wire is necessary for type B RCDs and EV/RDC.**

3. Repeatedly press Hot key 2 until the type of RCD you are testing is shown.
  - 3.1. Alternatively, press Hot key 2 once and use the right-hand rotary knob to select the type of RCD you are testing.
4. Repeatedly press Hot key 4 until the current rating of the RCD you are testing is shown.
  - 4.1. Alternatively, press Hot key 4 once and use the right-hand rotary knob to select the current rating of the RCD you are testing.



5. Repeatedly press Hot key 5 until the ramp icon  is shown.
  - 5.1. Alternatively, press Hot key 5 once and use the right-hand rotary knob to select the ramp () option.



6. Connect your test-leads to the circuit on the load side of the RCD you want to test.

Use a three-wire connection if you want the instrument to warn you of reversed L and N.

**NOTE :** Connection can be made at the end of the circuit, in the distribution board or on the RCD

**NOTE :** Some RCBOs will not trip if tested by connecting directly onto the screw terminals of the RCBO.

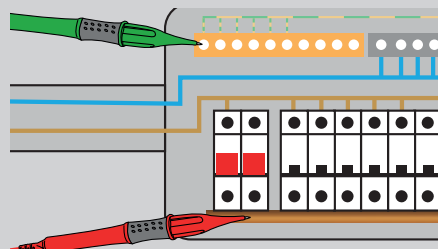

7. Press and release the test button to start the test.  
If the AUTO start function is enabled testing will start as soon as the instrument detects a live circuit, **Refer to 15.9.3 Auto start test on page 91.**

- The instrument automatically carries out the ramp test.
- During the test, the test current is shown on an analogue arc in the main display area.



- If the RCD trips, the test stops and the current at which it tripped is shown in the main display area.
- If the RCD does not trip, the test stops when the current reaches 110% of the RCD rating.

### 13.9 Touch-voltage test

The instrument automatically carries out a touch-voltage test before starting any of the RCD tests or the automatic test sequence. The result of this is shown in the low left window on the display.

The result is  $R_A \times I_{\Delta n}$ , where  $R_A$  is the resistance of the earthing path, relevant to the rating of the RCD fitted.

Follow these instructions if you want to carry out a touch-voltage test separately from the RCD tests.

The advantage is you don't need to trip an RCD to establish the touch voltage for the circuit.

1. Turn the left-hand rotary knob to the RCD test position (RCD).

- The display illuminates with a yellow background.

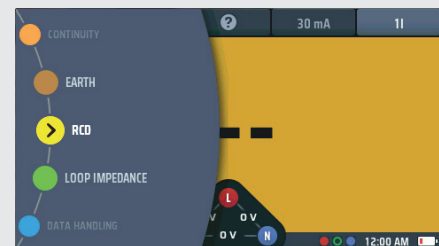

2. For two-wire testing, plug your L (red) test lead into the red socket and your PE test lead into the green socket.
- 2.1. For three-wire testing, plug your L (red) test lead into the red socket, your PE (green) test lead into the green socket and your N (blue) test lead into the blue socket.



or



3. Repeatedly press Hot key 2 until the type of RCD you are testing is shown.
- 3.1. Alternatively, press Hot key 2 once and use the right-hand rotary knob to select the type of RCD you are testing.



4. Repeatedly press Hot key 4 until the current rating of the RCD you are testing is shown.
- 4.1. Alternatively, press Hot key 4 once and use the right-hand rotary knob to select the current rating of the RCD you are testing.



5. Repeatedly press Hot key 5 until the touch-voltage test (Touch V) is shown.
- 5.1. Alternatively, press Hot key 5 once and use the right-hand rotary knob to select the touch-voltage test.



## Residual current device (RCD) testing

6. Connect your test-leads to the circuit on the load side of the RCD you want to test.  
Use a three-wire connection if you want the instrument to warn you of reversed L and N.

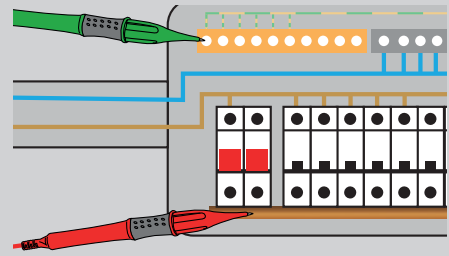

7. Press and release the test button to start the test.

If the AUTO start function is enabled testing will start as soon as the instrument detects a live circuit, **Refer to 15.9.3 Auto start test on page 91.**



8. The instrument shows the touch voltage in the main area of the display.

- The instrument provides a warning if the touch voltage is greater than 50 V. This can be changed to 25 V in Settings, **Refer to 15.9.2 Maximum touch voltage on page 91.**



**NOTE :** Connection can be made at the end of the circuit, in the distribution board or on the RCD

**NOTE :** Some RCBOs will not trip if tested by connecting directly onto the screw terminals of the RCBO.

### 13.10 VAR (Variable RCD)

To test an RCD with a rating that is not included in the standard ratings offered by the instrument, you can use the VAR option.

The VAR option allows selection of RCD values between 10 mA and 990 mA.

Before you use this option, you must set the rating of the RCD you want to test using the Set VAR option.

This is accessed using the SET VAR function on the right rotary wheel when Hot key 4 is active.

It CANNOT be accessed directly from the Hot key 4.

#### 13.10.1 Using the VAR option

The VAR option can be used in any of the RCD tests except Type B and EV modes.

The same maximum current limit applies to standard values. That is the maximum current cannot exceed 1000 mA. So, a 250 mA type AC test cannot be run at 5 x I as it will exceed 1000 mA.



### 13.10.2 Setting the VAR option

To set the VAR option

1. Turn the left-hand rotary knob to the RCD test position (RCD).
  - The display illuminates with a yellow background.

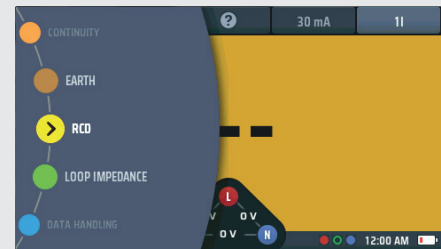

2. Press Hot key 4 to activate options and turn the right rotary knob to select Set VAR. The Set VAR option will automatically appear under Hot key 3.



**Be careful to choose the Set VAR option!**  
**This is not the same as the VAR option.**

**NOTE :** This function can ONLY be accessed on the right rotary knob.



Fig 47: Set VAR option

3. When you have selected Set VAR on the rotary knob, press Hot key 3, Set VAR.



4. The main area of the display changes to show three numbered discs. These discs show the rating of the RCD in mA.

The dark wheel is the active wheel.

So:

011 = 11 mA

127 = 127 mA

990 = 990 mA etc.

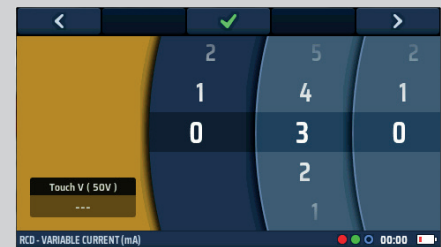

Fig 48: Set VAR numbered discs

5. To rotate a disc, select it using Hot key 1 and Hot key 5, then turn the right-hand rotary knob. The active disc is in dark blue.
6. Rotate each of the discs until the current rating, in mA, of the RCD you want to test is shown across the centre of the display.
7. When you have selected the current rating you want, press Hot key 3 to confirm it.
  - The VAR option is now set.

Pressing a test button will now run the selected test with the VAR value.



8. To change the VAR setting, repeat this procedure, remembering to press Hot key 3 to confirm the new setting.



## 14. Earth Loop Impedance testing – TrueLoop™

**WARNING : Loop impedance tests are live circuit tests and all precautions for live working must be followed.**

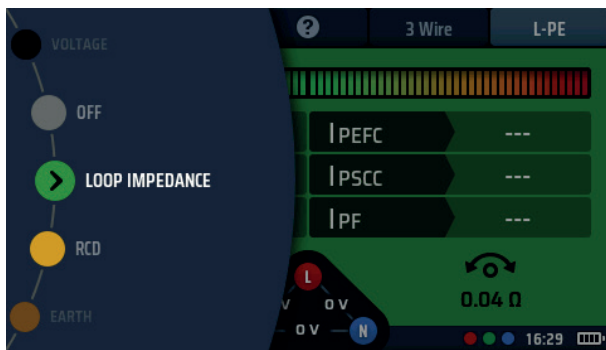

Fig 49: Selecting Loop Impedance mode

### 14.1 General

The MFT-X1 uses the unique Megger TrueLoop™ technology to carry out earth Loop Impedance measurements (which are often called Loop Impedance test or just loop tests) in single and three-phase installations. They can also be used to measure Loop Impedance of all line conductors such as Live to Neutral and Live to Live.

Test options include:

- No RCD: Two-wire standard and two-wire high-resolution tests for circuits that are not protected by RCDs.
- RCD: Two- and three-wire tests for circuits that are protected by RCDs and RCBOs, without tripping an RCD.
- EV RDC: Three-wire tests for EV circuits protected by a 6 mA RDC.

The tests for RCD- or RDC-protected circuits are very unlikely to trip the RCD but, as with all loop test instruments, there may be rare combinations of circumstances in which tripping occurs. Consequently, if the risk of tripping the RCD is too high, alternative methods of testing the circuit impedance should be considered.

#### 14.1.1 About Loop Impedance tests

Loop impedance tests are carried out on electrical installations for three reasons:

- To ensure that, if a fault occurs, a large enough fault current can flow to operate the protective device quickly.
- To allow the instrument to calculate the prospective fault current. This must always be less than the safe interrupting capacity of the protective devices in the circuit.
- To allow the instrument to calculate the volts drop in the wiring between the point where the supply enters the property (usually the consumer unit or main distribution board) and the point where the load is connected.

To measure the Loop Impedance, the instrument connects a load between live and earth or between live and neutral, depending on the test being performed, and measures the effect this has on the supply voltage at the point where the instrument is connected.

For testing across phases, the instrument can also be connected from L1 to L2, from L2 to L3 or from L1 to L3. The instrument uses the change in voltage to calculate the Loop Impedance.

When you are testing an installation, you will need to measure the Loop Impedance at the furthest point on a ring or radial circuit, referred to as  $Z_s$  ( $Z_s$  = the total Loop Impedance of the circuit right back to the transformer).

In most cases, you will need to measure  $Z_s$  at several locations – for a ring final circuit, this could be at every socket outlet – but you will only need to record the highest of the values you measure. On a radial circuit this will be the end of the circuit. To make this easier, the MFT-X1 has a  $Z_{max}$  function which stores and displays the highest out of a series of consecutive measurements (Refer to 14.9  $Z_{max}$  – to find the highest Loop Impedance for a circuit on page 74.).

### 14.1.2 Using the Confidence Meter™

During every loop test, the Confidence Meter™ bar appears at the top of the main display area.

- At the start of the test, the bar is wide and out to the red zone.



- As the test progresses and the instrument gets more confident about the result, the bar gets shorter, passing through amber.



- When the test is near to finishing and the instrument has a result with little variation, the bar becomes shorter still and it reduces in size to the green zone.



- And finally stops the test and displays a single green dot.



At this stage the result is considered to have a high degree of confidence in its accuracy, from where the Confidence Meter™ acquired its name.

On low-noise circuits, the test is completed more quickly than with ordinary instruments. On noisy circuits, the tests can take longer and the Confidence Meter™ bar may shorten and lengthen more than once during the test. When it finally changes to green, however, you can be confident that the result it shows is reliable. If there is a lot of electrical noise on the circuit being tested, it is possible that the Confidence Meter™ bar may never stop before reaching the green dot. In these cases, the test is still valid, but may not be as accurate.

In extreme cases the test will automatically stop after about 90 seconds. The result displayed is valid but is not guaranteed to reach the level of accuracy stated in the instrument specification.

## 14.2 Loop test options

Setting the Loop Impedance test options are best performed by setting up the Loop Impedance test from Hot key 1 to Hot key 5, as this gives a logical sequence to the selection. Each of the Hot key options are detailed below:

### 14.2.1 Hot key 1 – Types of loop test

- Z

This is the standard Loop Impedance test mode. It displays the basic Loop Impedance result plus the fault current. Depending on the other Hot key settings it can display all three loop Impedances, L-PE, L-N and N-PE or just a single result.

- Zmax

This mode displays the maximum Loop Impedance value from a series of tests, removing the need to manually record results when searching for the highest Loop Impedance in a circuit.

- Zref

This mode stores a Loop Impedance value, such as  $Z_e$ , for use when using the R1+R2 or Vdrop modes. In many cases this will be  $Z_e$ , the external part of the Loop Impedance circuit outside the building. But it could also be the entire circuit between the supply source to the last distribution board if all you want is the final circuit impedance.

Making a Zref measurement stores the Loop Impedance value automatically and is displayed in the lower left of the Loop Impedance screen of the R1+R2 and Vdrop test modes.

- R1+R2 (Only available when Hot key 5 is set to L-PE)

Once stored, by selecting the R1+R2 mode, the instrument subtracts the stored value of Zref from each measured result. For example, if you use Zref to store the external Loop Impedance of a circuit ( $Z_e$ ) and then measure using the R1+R2 mode, the instrument will subtract the Zref from the measured value and display the result. In this case the result will be the internal impedance or R1+R2 for the circuit under test (**Refer to 14.11 R1 + R2 mode on page 78.**). This option requires Hot key 5 to be set to L-PE as it is only valid when making phase to earth measurements.

- Vdrop

This mode uses the Zref value above plus a stored circuit current value to display the volt drop of a circuit.

Vdrop requires both the Zref value to be measured and the i-vdrop value to be entered (**Refer to 14.10 Zref – making and using the reference impedance for R1+R2 and Vdrop calculations on page 76.**)

### 14.2.2 Hot key 2 – No RCD, RCD or EV RDC options

- No RCD

This method will trip any RCD in the circuit so should only be used on phase to neutral (L-N) or phase to phase (L-L) circuits. The method uses test currents between 650 mA and 3.2 A, depending on supply voltage, the instrument measuring the unloaded and loaded voltages and calculating the loop resistance. The HR (High resolution) tests may take several seconds depending on the noise on the supply.

- RCD

This method uses a much lower test current designed to avoid tripping RCDs down to 30 mA.

- RDC EV

This method is designed specifically for EV charger installations fitted with 6 mA RDCs.

**NOTE :** There is always a very small risk that an RCD may trip during a test. If this is unacceptable, you may need to consider alternative methods of measuring the Loop Impedance. For further advice, contact the Megger technical support service ([uksupport@megger.com](mailto:uksupport@megger.com) or +44 (0) 1304 502 102)

### 14.2.3 Hot key 3 – No RCD, RCD or EV RDC options

Connection help screens

### 14.2.4 Hot key 4 – 2 wire, 2 wire HR and 3 wire methods

- 2 wire

This method only uses two connections to make the measurement. It will work on No RCD or RCD modes.

- 2 wire HR (high resolution)

This method uses the No RCD mode (high current) and gives result to 0.001  $\Omega$  resolution.

- 3 wire

This method is designed for RCD protected circuits and requires all three test-leads to be connected to the circuit.

It can ONLY be used on RCD or EV RDC modes, as No RCD mode will trip the RCD.

It will provide all three circuit results (L-PE, L-N and N-PE).

### 14.2.5 Hot key 5 – test-lead connections

The loop Impedance function allows all three leads to be connected to the circuit under test, either:

L (live or phase) + N (neutral) + PE (earth)

Or

L1 (phase 1) + L2 (phase 2) + L3 (phase 3)

Hot key 5 allows the operator to select different terminals to apply the test.

- L-PE

Testing the L-PE Loop Impedance.

For 3 wire testing the instrument report all three Loop Impedances L-PE, L-N and N-PE.

For 2 wire testing the instrument reports just the L-PE Loop Impedance.

- L-N

Testing the L-N Loop Impedance.

For use with 2 wire methods only.

- L1-L2

Testing the L1-L2 Loop Impedance.

For use with 2 wire methods only.

- L2-L3

Testing the L2-L3 Loop Impedance.

For use with 2 wire methods only.

- L3-L1

Testing the L3-L1 Loop Impedance.

For use with 2 wire methods only.

### 14.2.6 Test inhibit

The impedance test will be inhibited for several reasons, such as if:

- The supply voltage is outside the acceptable range (48 V AC to 280 V AC for nominal 230 V supplies and 376 V AC to 550 V AC for nominal 400 V AC supplies)
- The supply frequency is outside the acceptable range (45 Hz to 65 Hz for nominal 50 Hz or 60 Hz supplies).
- The touch voltage exceeds 25 V or 50 V depending on the Settings configuration.

You can change the touch voltage limit to 25 V in Settings **Refer to 15.9.2 Maximum touch voltage on page 91.**

### 14.3 Hot keys for Loop Impedance tests

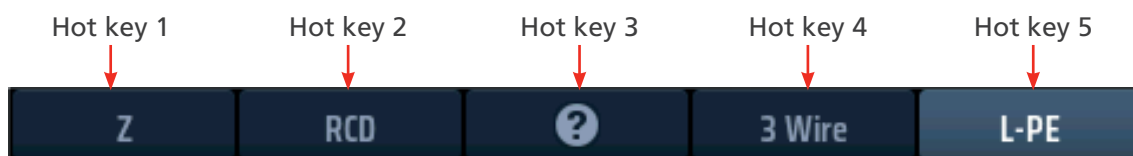

Fig 50: Loop impedance Hot keys

| Hot key | Function           | Description  |
|---------|--------------------|--|
| 1       | Measurement type   | Press repeatedly to select the type of measurement.<br>The options are:<br>Impedance (Z),<br>Maximum impedance (Zmax),<br>Reference impedance (Zref), for R1+R2 and Vdrop measurements<br>Internal impedance (R1 + R2),<br>Voltage-drop and (i-vdrop). The R1 + R2 and the I-volt drop options are only available under certain conditions, <b>Refer to 14.10 Zref – making and using the reference impedance for R1+R2 and Vdrop calculations on page 76.</b> |
| 2       | Circuit protection | Press repeatedly to select the type of circuit protection.<br>The options are: NO RCD, RCD, RCD EV.  |
| 3       | Help/Save          | Before starting a test, press for help on Loop Impedance testing.<br>When the test is complete, press to transfer the results if the MFT is connected to a Bluetooth® device running CertSuite™. <b>Refer to 16. Download results to a remote device on page 93.</b>   |
| 4       | Test type          | Press repeatedly to select the type of test.<br>The options are: 2 wire, 2 wire HR, and 3 wire. The 3 wire option is the preferred option for circuits with RCD protection.  |
| 5       | Test configuration | Press repeatedly to select the test configuration.<br>The options are L-PE, L-N, L1-L2, L2-L3, L3-L1   |

### 14.4 Test-lead null

To ensure best accuracy in a loop test, the MFT-X1 allows the test-lead resistance to be nulled. This prevents the lead resistance from adding to the Loop Impedance. The MFT-X1 uses the continuity test-lead null to achieve this.

When a test-lead is nulled in the continuity mode, the same value is used in the Loop Impedance mode. This allows different lead types to be used and quickly nulled.

For lead nulling procedure, **Refer to 7.2 Continuity testing on page 29.**

### 14.5 Loop test recommendation table

During the selection of a loop test combination the guidance table may appear. This table indicates the combination of tests selected that have been selected may not be possible or there may be a better option available.

|         |      | OK    |    |       |    |        |    |
|---------|------|-------|----|-------|----|--------|----|
|         |      | None  |    | RCD   |    | RDC EV |    |
| Test    | RCD  |       |    |       |    |        |    |
| L-PE    | None | 2W    | 3W | 2W    | 3W | 2W     | 3W |
|         | RCD  | 2W HR | 3W | 2W HR | 3W | 2W HR  | 3W |
| L-N/L-L | None | 2W    | 3W | 2W    | 3W | 2W     | 3W |
|         | RCD  | 2W HR | 3W | 2W HR | 3W | 2W HR  | 3W |

■ Available     
 ■ Possible     
 ■ Not available

**Fig 51: Loop test guidance table**

The table shows the combinations of tests we recommend for loop testing. For example:

If you select RCD type A/AC (because there is an RCD in the circuit you are testing, plus you select Live – Neutral (L-N) then the table will warn you the combination is not possible. This is because there is no reason to use an RCD compatible loop test mode when testing Live to Neutral, as shown below:

|         |      | OK    |    |       |    |        |    |
|---------|------|-------|----|-------|----|--------|----|
|         |      | None  |    | RCD   |    | RDC EV |    |
| Test    | RCD  |       |    |       |    |        |    |
| L-PE    | None | 2W    | 3W | 2W    | 3W | 2W     | 3W |
|         | RCD  | 2W HR | 3W | 2W HR | 3W | 2W HR  | 3W |
| L-N/L-L | None | 2W    | 3W | 2W    | 3W | 2W     | 3W |
|         | RCD  | 2W HR | 3W | 2W HR | 3W | 2W HR  | 3W |

**Fig 52: Loop test guidance table 2**

Change your selection to one of those marked in green or as a second best option, yellow.

## 14.6 Measuring Loop Impedance – No RCD in circuit

- Turn the left-hand rotary knob to the Loop Impedance test position.
  - The display illuminates with a green background.

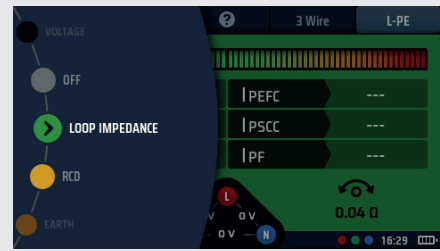

- Plug your L (red) test-lead into the red socket and your PE (green) test-lead into the green socket.



- Repeatedly press Hot key 1 to select impedance measurement (Z).
  - Alternatively, press Hot key 1 once and use the right-hand rotary knob to select impedance measurement (Z).



- Repeatedly press Hot key 2 to select no RCD.
  - Alternatively, press Hot key 2 once and use the right-hand rotary knob to select no RCD.



- Repeatedly press Hot key 4 to select either 2 wire or 2 wire HR testing.
  - Alternatively, press Hot key 4 once and use the right-hand rotary knob to select either 2 wire or 2 wire HR testing.



- Repeatedly press Hot key 5 to select L-PE, L-N or one of the three phase options L1-L2, L2-L3 or L3-L1.
  - Alternatively, press Hot key 5 once and turn the right-hand rotary knob to select L-PE, L-N or one of the three phase options L1-L2, L2-L3 or L3-L1.



The example shows an L-PE test using 2 wire with No RCD in circuit.

- Connect your test-leads to the conductors at the point on the circuit where you want to measure the Loop Impedance, either L-PE, L-N or one of the three phase options L1-L2, L2-L3 or L3-L1.
 

The example here shows connection for an L-PE measurement.

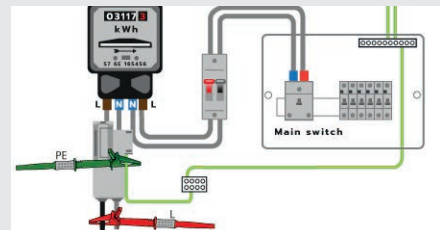

- Press and release the test button.
 

**NOTE :** If AUTO START is enabled in settings, press the test button BEFORE connecting the test-leads. The test will then start when it detects a live circuit on connection of the leads, **Refer to 15.8.3 Auto start test on page 90.**



- When the Confidence Meter™ bar reduces towards the middle as the circuit is analyzed.



- When the test is complete, the display shows the Loop Impedance, in this case ZL-PE and the prospective earth-fault current, IPEFC.





## 14.7 Measuring Loop Impedance (Zs) with RCD protection in circuit (3 wire)

1. Turn the left-hand rotary knob to the Loop Impedance test position (Z).

- The display illuminates with a green background.

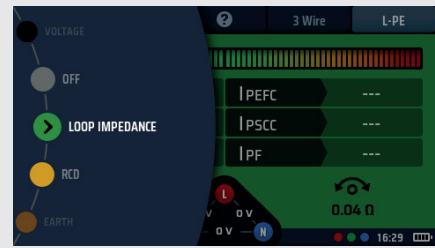

2. For a 3 wire test, plug your L test-lead into the red socket, your PE test-lead into the green socket and your N test-lead into the blue socket.

- 2.1. For a 2 wire test, plug your red (red) test-lead into the red socket and your PE (green) test-lead into the green socket.



or



3. Repeatedly press Hot key 1 to select impedance measurement (Z).

- 3.1. Alternatively, press Hot key 1 once and use the right-hand rotary knob to select impedance measurement (Z).



4. Repeatedly press Hot key 2 to select the type of RCD protecting the circuit (RCD), either RCD or RDC EV.

- 4.1. Alternatively, press Hot key 2 once and use the right-hand rotary knob to select the type of RCD protecting the circuit, either RCD or RDC EV.



5. Repeatedly press Hot key 4 to select either 2 wire or 3 wire testing. The example (right) uses 3 wire connection.

- 5.1. Alternatively, press Hot key 4 once and use the right-hand rotary knob to select either 2 wire or 3 wire testing.



6. Repeatedly press Hot key 5 to select L-PE.

- 6.1. Alternatively, press Hot key 5 once and use the right-hand rotary knob to select L-PE.



7. Connect your test-leads to the L and PE conductors at the point on the circuit where you want to measure the Loop Impedance.

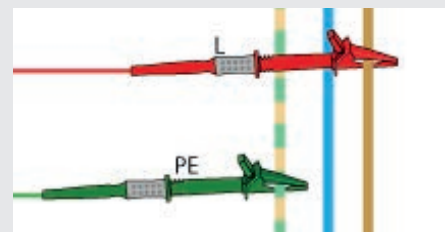

8. Press and release the test button.

**NOTE :** If AUTO START is enabled in settings, press the test button BEFORE connecting the test-leads. The test will then start when it detects a live circuit on connection of the leads, **Refer to 15.8.3 Auto start test on page 90.**



9. When the Confidence Meter™ bar reduces towards the middle as the circuit is analyzed.



## Earth Loop Impedance testing – TrueLoop™

10. When the test is complete, the display shows the Loop Impedance (ZL-PE) and the LPEFC current.

If the 3 wire method was used, the display will also show the L-N and N-PE Loop Impedances as well as the IPSCC current as shown here.



**NOTE :** The 2 wire and 3 wire options can be used to measure the loop impedance test for a circuit protected by a 30 mA Type B RCD. If the circuit contains a 6mA DC RDC protecting a 30 mA Type A RCD then 3 connections will be required and the RDC EV setting must be selected.

### 14.8 Measuring EV charger Loop Impedance

For circuits with an EV charger the process for measuring Loop Impedance is the same as for standard RCD protected circuits (**Refer to 14.7 Measuring Loop Impedance (Zs) with RCD protection in circuit (3 wire) on page 73.**), with the following exceptions:

- For EV chargers fitted with RDC-DD devices, use the RDC EV mode on Hot key 2.
- For EV chargers fitted without RDC-DD devices, use the standard RCD mode on Hot key 2.

This measurement can use either the 3 wire method or 2 wire method.

3 wire is preferred as it is quicker than the 2 wire method.

### 14.9 Zmax – to find the highest Loop Impedance for a circuit

Zmax can be used in ANY Loop Impedance mode, the example below uses the 2 wire and L-PE test option for a circuit with an RCD.

Zmax will continually display the highest Loop Impedance measured in the low right of the display, as well as the last measurement the instrument made, so long as no Hot key settings are changed.

1. Turn the left-hand rotary knob to the Loop Impedance test position (Z).
  - The display illuminates with a green background.



2. Plug your red L test-lead into the red socket and your green PE test-lead into the green socket.



3. Repeatedly press Hot key 1 to select the Zmax function.
  - 3.1. Alternatively, press Hot key 1 once and use the right-hand rotary knob to select the Zmax function.



4. Repeatedly press Hot key 2 to select RCD.
  - 4.1. Alternatively, press Hot key 2 once and use the right-hand rotary knob to select RCD.



5. Repeatedly press Hot key 4 to select 2 wire, 2 wire HR or 3 wire testing. The 2 wire HR option is only available for circuits with No RCD option selected.

5.1. Alternatively, press Hot key 4 once and use the right-hand rotary knob to select 2 wire, 2 wire HR or 3 wire testing. The 2 wire HR option is only available for circuits with No RCD option selected.



6. Repeatedly press Hot key 5 to select L-PE.

6.1. Alternatively, press Hot key 5 once and use the right-hand rotary knob to select L-PE.



7. Connect your test-leads to the L and PE conductors at the point on the circuit where you want to measure the Loop Impedance.

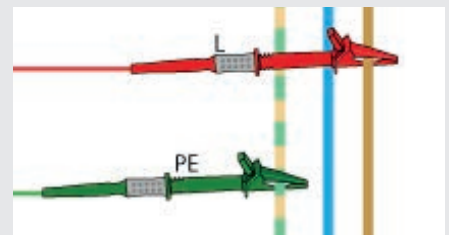

8. Press and release the test button.

**NOTE :** If AUTO START is enabled in settings, press the test button BEFORE connecting the test-leads. The test will then start when it detects a live circuit on connection of the leads.

**Refer to 15.8.3 Auto start test on page 90.**



9. When the Confidence Meter™ bar reduces towards the middle as the circuit is analyzed.



10. The display shows the Loop Impedance (Z<sub>L-PE</sub>) and the prospective earth-fault current, IPEFC. It also shows Z<sub>max</sub> which, for the first test in a series, will be the same as Z<sub>L-PE</sub>.



11. Reconnect the instrument at the next point where you want to measure Z<sub>max</sub>. If AUTO START is enabled in settings press the test button BEFORE connecting the test-leads.

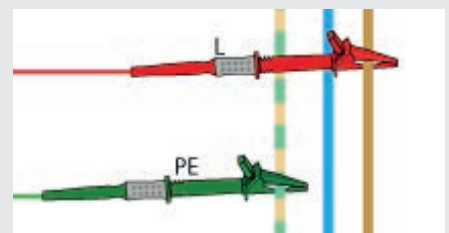



12. Press and release the test button if AUTO START is not enabled.



13. When the Confidence Meter™ bar reduces towards the middle as the circuit is analyzed.

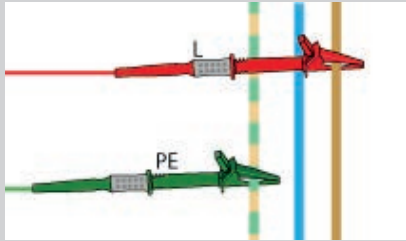
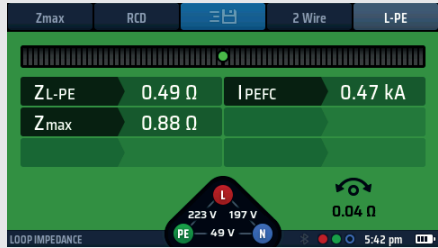

## Earth Loop Impedance testing – TrueLoop™

|   |  |
|---|--|
| <p>14. After each test, the display shows the Loop Impedance (ZL-PE) and the prospective earth-fault current, IPEFC, for the most recent test. It also shows Zmax, which is the highest value of impedance measured in any of the tests.</p>  |  |
| <p>15. After each test, the displays shows the Loop Impedance (ZL-PE) and the prospective earth-fault current, IPEFC, for the most recent test.</p> <ul style="list-style-type: none"> <li>It also shows Zmax, which is the highest value of impedance measured in any of the tests.</li> </ul> |  |
| <p>16. The Zmax value is stored until any Hot key setting is changed.</p>   |  |

### 14.10 Zref – making and using the reference impedance for R1+R2 and Vdrop calculations

Zref is used in the R1+R2 and V-Drop test modes and MUST be stored before these tests can be run.



For R1+R2 measurements Zref is usually the L-PE measurement at the point the supply enters the building.





For Vdrop, the Zref is normally the L-N or L-L measurement at the point the supply enters the building.

Zref is usually the external Loop Impedance of a circuit but can include all of a circuit up to the final section closest to the load.

In R1+R2 and V-Drop modes the Zref value is deducted from the total circuit impedance to leave only the final circuit or R1+R2 Loop Impedance, or the V-drop of the circuit excluding the Zref part.

Zref is always stored automatically. It will only appear in test modes that require Zref and be displayed in the lower left of the screen.

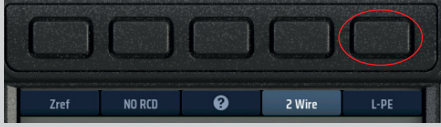

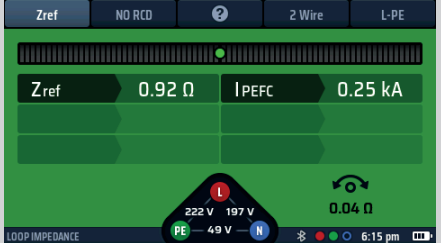



|   |  |
|---|--|
| <p>1. Turn the left-hand rotary knob to the Loop Impedance test position (Z).</p> <p>1.1. The display illuminates with a green background.</p>          |  |
| <p>2. Plug your L (red) test-lead into the red socket and your PE (green) test-lead into the green socket.</p>  |  |
| <p>3. Repeatedly press Hot key 1 to select Zref.</p> <p>3.1. Alternatively, press Hot key 1 once and use the right-hand rotary knob to select Zref.</p> |  |

|   |  |
|---|--|
| <p>4. Repeatedly press Hot key 2 to select No RCD.</p> <p><b>NOTE :</b> If an RCD is present use the RCD option.</p> <p>4.1. Alternatively, press Hot key 2 once and use the right-hand rotary knob to select No RCD.</p>   |    |
| <p>5. Repeatedly press Hot key 4 to select either 2 wire or 2 wire HR testing. In this case 2 wire.</p> <p>5.1. Alternatively, press Hot key 4 once and use the right-hand rotary knob to select either 2 wire or 2 wire HR testing.</p>                            |    |
| <p>6. Repeatedly press Hot key 5 to select L-PE for R1+R2 measurement or L-N for Vdrop measurement.</p> <p>6.1. Alternatively, press Hot key 5 once and use the right-hand rotary knob to select L-PE.</p>  |    |
| <p>7. Connect your test-leads to the L and PE conductors of the supply at the point where it enters the building.</p> <p>8. Press and release the test button.<br/>If AUTO START is enabled in settings press the test button BEFORE connecting the test-leads.</p> |  |
| <p>9. The Confidence Meter™ bar reduces towards the middle as the circuit is analyzed.</p>  |  |
| <p>10. When the test is complete, the display shows the external reference impedance (Zref).</p>  |  |
| <p>11. The instrument stores the value of Zref even if you turn the instrument off.</p>   |  |
| <p>12. To update Zref, repeat the measuring procedure.</p>  |  |

### 14.11 R1 + R2 mode

**ATTENTION :** You can only select R1+R2 on Hot key 1 when you have L-PE selected on Hot key 5. This is because R1+R2 is only used for the phase to earth impedances of final circuit measurements.

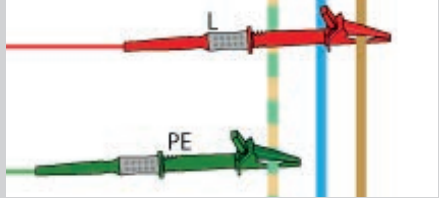
You can only measure R1+R2 if you have measured Zref first (Zref is automatically stored when made).

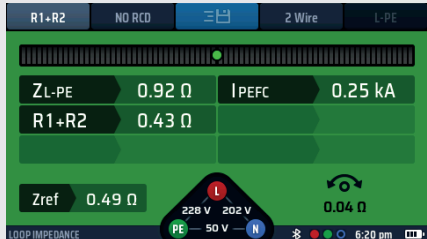
|   |   |
|---|---|
| <ol style="list-style-type: none"> <li>Turn the left-hand rotary knob to the Loop Impedance test position.</li> <li>The display illuminates with a green background.</li> </ol>   |     |
| <ol style="list-style-type: none"> <li>Plug your L (red) test-lead into the red socket and your PE (green) test-lead into the green socket.</li> </ol>  |     |
| <ol style="list-style-type: none"> <li>Ensure you have Hot key 5 in L-PE mode before repeatedly pressing Hot key 1 to select R1+R2.             <ol style="list-style-type: none"> <li>Alternatively, press Hot key 1 once and use the right-hand rotary knob to select R1+R2.</li> </ol> </li> </ol> <p><b>REMEMBER:</b> Hot key 5 MUST be in L-PE to allow R1+R2 to be selected on Hot key 1 or R1+R2 will not appear as an option!</p> |     |
| <ol style="list-style-type: none"> <li>Repeatedly press Hot key 2 to select No RCD or RCD if one is present.             <ol style="list-style-type: none"> <li>Alternatively, press Hot key 2 once and use the right-hand rotary knob.</li> </ol> </li> </ol>  |   |
| <ol style="list-style-type: none"> <li>Repeatedly press Hot key 4 to select either 3 wire, 2 wire or 2 wire HR testing. This example is using 2 wire.             <ol style="list-style-type: none"> <li>Alternatively, press Hot key 4 once and use the right-hand rotary knob.</li> </ol> </li> </ol>   |   |
| <ol style="list-style-type: none"> <li>Connect your test-leads to the L and PE conductors of the supply at the point where it enters the building.</li> <li>If using the 3 wire mode connect all three test-leads.</li> </ol>   |   |
| <ol style="list-style-type: none"> <li>Press and release the test button.</li> </ol> <p>If AUTO START is enabled in settings press the test button BEFORE connecting the test-leads.</p>  |  |
| <ol style="list-style-type: none"> <li>The Confidence Meter™ bar reduces towards the middle as the circuit is analyzed.</li> </ol>  |   |
| <ol style="list-style-type: none"> <li>When the test is complete, the display shows the R1+R2 value and the Zref used to calculate it.</li> </ol>   |   |

## 14.12 Setting i-vdrop for volts drop measurements

### 14.12.1 Volt drop

#### How to measure the volt-drop of a circuit

Volt drop is the voltage the supply will fall to under maximum load current for a circuit. This is NOT the maximum fault current, but the circuit current. This is usually the rating of the MCB protecting that circuit.

Volt drop is the Phase to Neutral (L-N) voltage of a circuit, or the Phase to Phase (L-L) voltage. It is NOT the Phase to Earth voltage. Consequently, you should only need to use the L-N or L-L options of Hot key 5.

The instrument calculates the volt-drop based on the Loop Impedance for the circuit and the maximum rated current for the circuit. This means it is the volt drop in the conductors between the point where you measured and stored Zref, usually the point the supply enters the building and the end of the circuit.

**ATTENTION :** The instrument can only calculate the volt drop if you have stored a value for Zref, and also set the maximum current for the circuit called i-vdrop.

### 14.12.2 Setting Zref

Set the Zref (**Refer to 14.10 Zref – making and using the reference impedance for R1+R2 and Vdrop calculations on page 76.**). Remember this is usually the point the supply enters the building, or as close as is safely practicable.

**NOTE :** To measure the volt drop between the point the supply enters the building and the end of a final circuit, measure Zref at the point the phase and neutral enter the building.

### 14.12.3 Setting i-vdrop

i-vdrop is set manually

1. Turn the left-hand rotary knob to the Loop Impedance test position (Z).
  - The display illuminates with a green background.

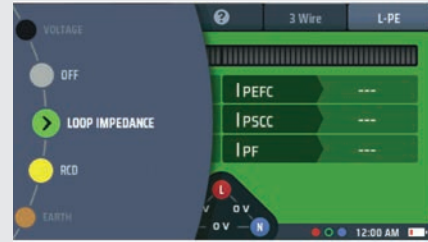

2. Repeatedly press Hot key 1 until Vdrop is shown.
  - 2.1. Alternatively, press Hot key 1 once and use the right-hand rotary knob.

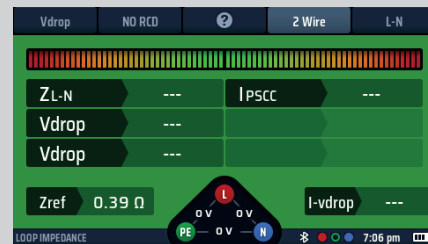

3. Turn the right rotary knob to select Set i-vdrop. Hot key 3 will change to Set i-vdrop for 3 seconds. Press Hot key 3 to accept.

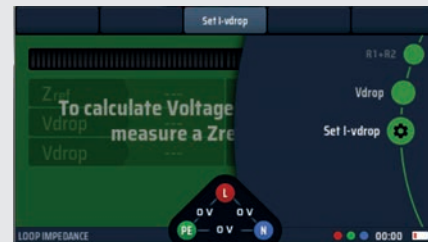
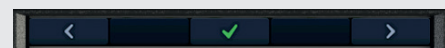
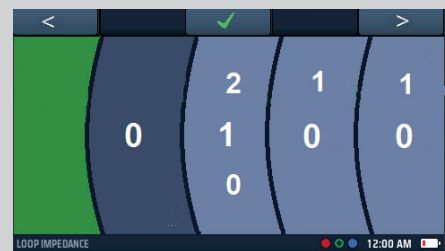

Fig 53: Set i-vdrop option



4. The main area of the display changes to show four numbered discs. These represent the maximum circuit current. Typically, this can be found on the MCB protecting that circuit.
5. To set the circuit current each disc is rotate to dial up the correct current in Amps. Select a disc using Hot key 1 and Hot key 5, then turn the right-hand rotary knob.
  - Rotate each of the discs until the maximum current for the circuit in amps, is shown across the centre of the display. For example, the diagram shows a current rating of 100 A.
6. When you have selected the current rating you want, press Hot key 3 to confirm it.
  - The circuit maximum current (i-vdrop) is now set and will be shown in the lower right of the V-drop display.
7. To change the i-vdrop current, repeat this procedure, remembering to press Hot key 3 to confirm the new setting.





### 14.12.4 Making a Volt drop measurement

**NOTE :** This is a Phase to Neutral (L-N) or Phase to Phase (L-L) measurement. You do NOT need to use the 3 wire measurement mode.

|   |   |
|---|---|
| <ol style="list-style-type: none"> <li>1. Turn the left-hand rotary knob to the Loop Impedance test position (Z).</li> <li>1.1. The display illuminates with a green background.</li> </ol>   |     |
| <ol style="list-style-type: none"> <li>2. Plug your L (red) test-lead into the red socket, your N (blue) test-lead into the blue socket.</li> </ol>   |     |
| <ol style="list-style-type: none"> <li>3. Repeatedly press Hot key 1 to select Vdrop.</li> <li>3.1. Alternatively, press Hot key 1 once and use the right hand rotary knob to select Vdrop.</li> </ol>  |     |
| <ol style="list-style-type: none"> <li>4. Repeatedly press Hot key 2 to select No RCD.</li> <li>4.1. Alternatively, press Hot key 2 once and use the right hand rotary knob to select No RCD.</li> </ol>  |     |
| <ol style="list-style-type: none"> <li>5. Repeatedly press Hot key 4 to select either 2 wire or 2 wire HR.</li> <li>5.1. Alternatively, press Hot key 4 once and use the right hand rotary knob.</li> </ol>   |   |
| <ol style="list-style-type: none"> <li>6. Repeatedly press Hot key 5 to select L-N. or L-L depending on the circuit you are measuring.</li> <li>6.1. Alternatively, press Hot key 5 once and use the right hand rotary knob to select L-N or L-L.</li> </ol>  |   |
| <ol style="list-style-type: none"> <li>7. Connect your test-leads to the L and N conductors at the point on the circuit where you want to calculate the volt drop.</li> <li>8. Press and release the test button.</li> </ol> <p>If AUTO START is enabled in settings press the test button BEFORE connecting the test-leads.</p>                                  |  |
| <ol style="list-style-type: none"> <li>9. The Confidence Meter™ bar reduces towards the middle as the circuit is analyzed.</li> </ol>   |   |
| <ol style="list-style-type: none"> <li>10. When the test is complete, the display shows the calculated volt drop in volts and as a percentage of the supply voltage. It will also display the Line to Neutral Loop Impedance (ZL-N) or the Phase to Phase impedance (depending on Hot key 5 setting, and the prospective short-circuit current, IPSSC.</li> </ol> |   |

### 14.12.5 Sources of error in measurements

Loop measurements can be influenced by noise on the supply, where possible switch potential noise sources off when testing. Tests should be made using the test set with prods, making a firm connection to clean conductors. Loop measurements close to the source of supply will be influenced by the reactance component of the impedance. Measurements with system phase angles  $\leq 30^\circ$  will be within the required operational uncertainty. Loop measurements can be influenced by leakage currents.

## 15. Instrument settings navigation

The MFT-X1 provide a wide range of setting options that you can use to configure them to suit your own requirements and the way you work. You set almost all these options using the instrument set up features described in this section. A small number of options are selected as part of the test procedure for a particular test, such as Zref, i-vdrop and lead null, but where this is the case, the options are clearly described in the section dealing with that test.

To make it easier to find and select the options you want, the SETTINGS options are divided into six pages:

- General
- RCD
- Loop impedance – Z
- Continuity – R<sub>Lo</sub>
- Insulation – R<sub>iso</sub>
- Instrument information – Inst.

### 15.1 Settings screen navigation

You access the page you want by selecting the appropriate tab at the top of the settings screen, **Refer to 15.3 Entering and leaving settings mode on page 83**. When you have the selected the page, it shows only the relevant set-up options. For example, if you select the continuity page it shows only the options relevant to continuity testing.

All of the settings you make in set up are retained when you turn the instrument off. If you want to cancel or change a setting, you will need to repeat the appropriate set up procedure.

### 15.2 Hot keys in settings mode

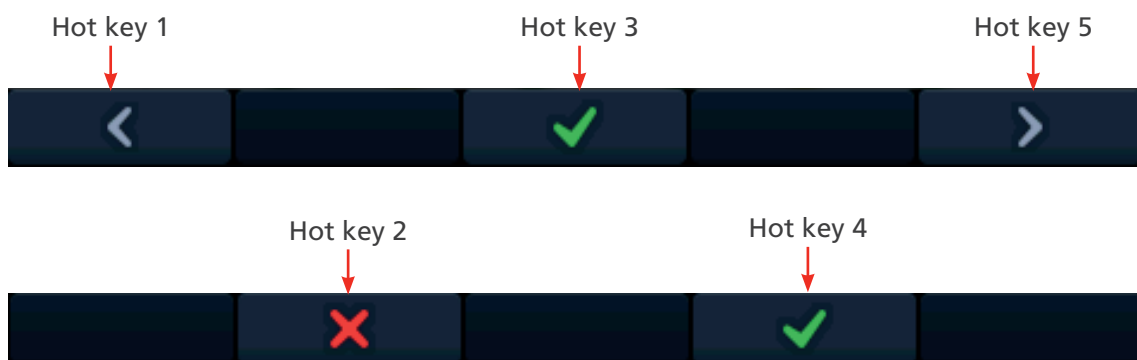

| Hot key | Function     | Description   |
|---------|--------------|---|
| 1       | Left cursor  | Press to move the cursor or highlight to the left (except in RCD auto sequence setting when it moves the cursor to the previous cell).  |
| 2       | X            | Used to decline a request to make a change.   |
| 3       | Select       | Press to accept a change or to switch between two options (not used for touch voltage setting).   |
| 4       | √            | Used to accept a request to make a change.  |
| 5       | Right cursor | Press to move the cursor of the highlight to the right (except in RCD auto sequence setting when it moves the cursor to the next cell). |

### 15.3 Entering and leaving settings mode

1. Turn the left-hand rotary knob to the SETTINGS position. The display will default to the general options page.

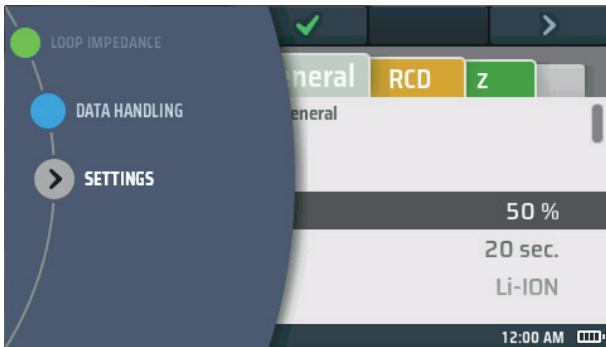

**Fig 54:** Settings

2. To leave set-up mode, turn the left-hand rotary knob to any position except the SETTINGS position.
3. When you leave SETTINGS mode any changes you have made will be stored, even if you turn the instrument off.

### 15.4 Selecting a settings page

1. Enter settings mode.
2. The settings screen appears with a row of tabs at the top.
3. Use Hot key 1 and Hot key 5 to highlight the tab for the page where you want to make changes.
4. When the tab for the correct page is highlighted, press Hot key 3 to go to that page.
5. To go to a different page, use Hot key 1 and Hot key 5 to highlight the tab for the new page and press Hot key 3 again.

### 15.5 General settings

1. Select the general tab.
2. Turn the right-hand knob to highlight the setting you want to change.  
The options are :
 

|                   |                   |                            |
|-------------------|-------------------|----------------------------|
| ▪ Brightness      | ▪ Key press beep  | ▪ Network connection       |
| ▪ Backlight timer | ▪ Results beep    | ▪ Clear network pairings   |
| ▪ Contrast mode   | ▪ Sleep timer     | ▪ Restore factory settings |
| ▪ Date            | ▪ Language        |                            |
| ▪ Time            | ▪ PE confirmation |                            |
3. Press Hot key 3 to confirm your selection or to change the status if it is an ON/OFF function.

## Instrument settings navigation

### 15.5.1 Screen brightness

1. Select the screen brightness option and press the check Hot key (3) to enter.
2. Turn the right-hand rotary knob to select the brightness setting you want.  
The choices are 10% to 100% in 10% steps
3. When you have made your selection either press Hot key 3 to confirm it or wait three seconds for automatic confirmation.

### 15.5.2 Backlight timer

1. Select the backlight timer option and press the green check Hot key 3.
2. Turn the right-hand rotary knob to choose how long the backlight stays on before being turning off automatically. The choices are:
  - 20 seconds
  - 60 seconds
  - Never – The backlight stays on permanently. **This can cause excessive battery usage.**
3. When you have made your selection either press the green check button (Hot key 3) to confirm or wait three seconds for automatic confirmation.

### 15.5.3 Contrast mode

1. Select the screen contrast mode option.
2. Press Hot key 3 to swap between colour and black-and-white.
3. Your choice is stored automatically.

### 15.5.4 Setting the date

1. Select the date option.
2. The main area of the display changes to show four discs (see the diagram below).

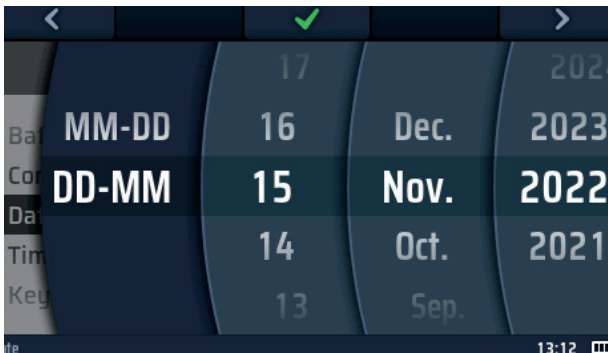

**Fig 55:** *Setting the date*

3. To rotate a disc, select it using Hot key 1 and Hot key 5, then turn the right-hand rotary knob.

**NOTE :** The dark disc is the active disc.

4. Select the left-hand disc.
5. Rotate it to select the date format. The choices are MM-DD (month, day) or DD-MM (day, month).
6. Use Hot key 5 to move to the second disc from the left.
7. Rotate the disc to select the day of the month.
8. Use Hot key 5 to move to the third disc from the left.
9. Rotate the disc to select the month.
10. Use Hot key 5 to select the fourth disc from the left.
11. Rotate the disc to select the year.
12. Press Hot key 3 to confirm and store the date setting.

### 15.5.5 Setting the time

1. Select the time option, **Refer to 15.5 General settings on page 83.**
2. The main area of the display changes to show four discs

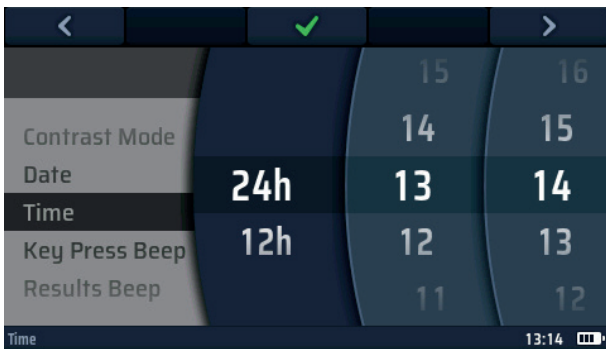

**Fig 56:** *Setting the time*

3. To rotate a disc, select it using Hot key 1 and Hot key 5, then turn the right-hand rotary knob.
4. Select the left-hand disc.
5. Rotate it to select either 24 hour or 12 hour clock.

**NOTE :** Selecting 12 hour clock will add a fourth wheel for AM or PM

6. Use Hot key 5 to move to the second disc from the left.
7. Rotate the disc to select the hour.
8. Use Hot key 5 to move to the third disc from the left.
9. Rotate the disc to select the minutes.
10. Use Hot key 5 to select the fourth disc from the left for AM or PM if a 12 hour clock is selected.
11. Rotate the disc to select either AM or PM (this setting is not available if you have chosen the 24 hour clock setting).
12. Press Hot key 3 to confirm and store the time setting.

### 15.5.6 Key press beep

1. Select the key press beep option.

**NOTE :** If this option is on, the instrument beeps every time you press a key.

2. Press Hot key 3 to turn the key press beep off or on.
3. Your choice is stored automatically.

### 15.5.7 Results beep

1. Select the results beep option.
  - If this option is on, the instrument beeps when a measurement is complete and the results are ready.
2. Press Hot key 3 to turn the results beep off or on.
3. Your choice is stored automatically.

### 15.5.8 Sleep timer

The sleep timer sets how long the instrument will stay switched on if it is not being used before turning off automatically to conserve battery power.

1. Select the sleep timer option.
2. Press the green check button (Hot key 3).
3. Turn the right-hand rotary knob to choose how long the instrument will stay switched on  
The choices are:
  - 5 minutes
  - 10 minutes
  - 20 minutes
  - 30 minutes
  - 60 minutes
  - Disabled – This mode can reduce battery life if left on
4. When you have made your selection either press Hot key 3 to confirm it or wait three seconds for automatic confirmation.

### 15.5.9 Language

1. Select the language option.
2. Turn the right-hand rotary knob to select the language the instrument will use on its display.  
The choices are:
  - English
  - German
  - French
  - Spanish
3. When you have made your selection either press Hot key 3 to confirm it or wait three seconds for automatic confirmation.

### 15.5.10 PE confirmation

PE confirmation is a function that displays a warning when there is voltage present between the instrument and the earth. It is detected whenever the operator places their finger on the red TEST button.

Two options are available:

- Warn the user with the hazard warning icon in the display and inhibit the test when an issue is detected
- Warn the user with the hazard warning icon but allow the test to proceed.

**WARNING : By switching off the inhibit the operator could be in risk of electric shock.**

1. Select the PE confirmation option.
  - If this option is on, the instrument inhibits testing if it detects a voltage greater than 75 V AC between the user and protective Earth.
2. Press Hot key 3 to turn PE confirmation off or on.
3. Your choice is stored automatically.

### 15.5.11 Network connection

This is the ON/OFF for Bluetooth® communications. When switched to ON a Bluetooth® icon appears in the bottom information bar and flashes ON/OFF to indicate the instrument has active Bluetooth®.

This must be set to ON before an instrument can be connected to a mobile device.

1. Select the network connection option.
  - If this option is on, the instrument can send results to a connected device via Bluetooth®. If it is off, the instrument cannot communicate via Bluetooth®.
2. Press Hot key 3 to turn network connection off.
3. Press Hot key 3 again to turn network connection back on.
4. Your choice is stored automatically.

### 15.5.12 Clear network pairings

The MFT-X1 does not need to be connected to a mobile device for it to connect to the same device. However, the MFT-X1 can be connected to a mobile device if the operator is not familiar with the connection process between the MFT and the mobile device. This is most likely if the instrument is a pool instrument used by several people.

If there are problems connecting the MFT to a mobile device the operator can clear any connection that the instrument may have recorded. To do this:

1. Select the Clear Network pairings option
2. Press the green check button (Hot key 3).
3. Confirm the connections are to be cleared by pressing the green check button (Hot key 4)
4. All Bluetooth® connections will be removed.

### 15.5.13 Reset to factory settings

1. Select the reset to factory settings option.
2. A warning screen appears asking if you want to proceed.
3. If you do NOT want to proceed, press Hot key 2.
4. If you DO want to reset to factory settings, press Hot key 4 and hold it for 3 seconds.
5. A progress bar appears on Hot key 4 during the 3 second countdown.
6. At the end of 3 second, all the settings and data in your instrument are erased, and all factory default settings are restored.

## 15.6 Continuity test settings $R_{Lo}$

- Select the insulation resistance tab from the settings page.

### 15.6.1 Continuity buzzer threshold (limit alarm)

The optional buzzer mode in continuity testing has a trigger resistance above which the buzzer will not sound. This allows for quick testing when only audible confirmation the circuit resistance is below a given threshold is required, rather than an absolute value. This threshold is called a limit alarm.

1. Select the continuity tab  $R_{Lo}$  from the General settings page using the right arrow (Hot key 5).
2. Press the green check button (Hot key 3).
3. Turn the right-hand rotary knob to choose the continuity buzzer limit alarm threshold.

The choices are:

- |                |                |
|----------------|----------------|
| ■ 0.3 $\Omega$ | ■ 10 $\Omega$  |
| ■ 0.5 $\Omega$ | ■ 20 $\Omega$  |
| ■ 1 $\Omega$   | ■ 30 $\Omega$  |
| ■ 2 $\Omega$   | ■ 40 $\Omega$  |
| ■ 3 $\Omega$   | ■ 50 $\Omega$  |
| ■ 4 $\Omega$   | ■ 100 $\Omega$ |
| ■ 5 $\Omega$   | ■ 200 $\Omega$ |

4. When you have made your selection either press Hot key 3 to confirm it or wait three seconds for automatic confirmation.
5. When you have made your selection either press Hot key 3 to confirm it or wait three seconds for automatic acceptance.

## 15.7 Insulation resistance settings

1. Select the insulation  $R_{iso}$  tab from the General settings page using the right arrow (Hot key 5).
2. Turn the right-hand knob to highlight the setting you want to change.

The options are:

- |                         |                       |
|-------------------------|-----------------------|
| ■ Buzzer threshold      | ■ Timed test duration |
| ■ Live voltage limit    | ■ Variable voltage    |
| ■ Lock button available |                       |

3. Press Hot key 3 to confirm your selection.

### 15.7.1 Live voltage limit

When you are performing an insulation test, if the instrument detects a voltage on the circuit you are testing, that is greater than the live voltage limit you have set, it will give an audible and visual warning you and inhibit the test.

1. Select the live voltage limit option using the right rotary knob.
2. Turn the right-hand rotary knob to select the live voltage limit you want.

The choices are:

- 30 V
- 50 V
- 75 V

3. When you have made your selection either press Hot key 3 to confirm it or wait three seconds for automatic confirmation.



### 15.7.2 Lock button available

If this option is on, you can use Hot key 2 during an insulation test to lock the insulation test on. If it is off, you cannot lock insulation tests on.

1. Select the lock button using the right rotary knob.
2. Press Hot key 3 to turn lock button to ON or OFF.
3. Your choice is stored automatically.

### 15.7.3 Variable voltage

To change the test voltage of the VAR setting of the insulation test voltage option.

1. Select the lock button using the right rotary knob.
2. Press the green check button (Hot key 3) to enter the variable options screen.
3. Using the left and right arrow buttons (Hot keys 1 and 5) and the right rotary knob, set the three number dials to the required voltage.
4. Press the green check button (Hot key 3) to accept the selection.

### 15.7.4 Insulation buzzer threshold (limit alarm)

The optional buzzer mode in insulation testing has a trigger resistance below which the buzzer will not sound. This allows for quick testing when only audible confirmation the circuit insulation is above a given threshold is required, rather than an absolute value. This threshold is called a limit alarm.

1. Select the insulation threshold option using the right arrow (Hot key 5).
2. Press the green check button (Hot key 3).
3. Turn the right-hand rotary knob to choose the insulation buzzer limit alarm threshold.

The choices are:

- |          |           |
|----------|-----------|
| ▪ 0.5 MΩ | ▪ 10 MΩ   |
| ▪ 1 MΩ   | ▪ 20 MΩ   |
| ▪ 2 MΩ   | ▪ 50 MΩ   |
| ▪ 3 MΩ   | ▪ 100 MΩ  |
| ▪ 4 MΩ   | ▪ 200 MΩ  |
| ▪ 5 MΩ   | ▪ 500 MΩ  |
| ▪ 7 MΩ   | ▪ 1000 MΩ |

4. When you have made your selection either press Hot key 3 to confirm it or wait three seconds for automatic confirmation.

### 15.7.5 1000 V test

To reduce the risk of accidental circuit damage the 1000 V insulation test is disabled as default.

1. Select the 1000 V test option using the right rotary knob.
2. Press the green check button (Hot key 3) to enable or disable the 1000 V insulation option.
3. The setting is saved automatically.

### 15.8 Loop impedance settings

1. Select the Loop Impedance page from the set-up page.
2. Turn the right-hand knob to highlight the setting you want to change.  
The options are
  - Allow reverse polarity
  - Max touch voltage
  - Auto Start Test

#### 15.8.1 Allow reverse polarity

This mode allows a Loop Impedance test to either prevent or allow a Loop Impedance test when it detects a reversed phase and neutral condition.

If this option is on, the instrument will allow Loop Impedance tests to continue even if it detects that the live and neutral connections are reversed, but it will still provide a warning. If this option is off, the instrument will inhibit Loop Impedance tests if it detects that the live and neutral connections are reversed.

1. Select the allow reverse polarity option using the right-hand range knob.
2. Press Hot key 3 to change the behavior on detecting a reverse L-N connection from allowed ON to allowed OFF. The MFT will state that the change will also be applied to RCD testing. Press green check button (Hot key 4) to accept or red cross (Hot key 2) to decline.
3. Your choice is stored automatically.

#### 15.8.2 Maximum touch voltage

1. Select the maximum touch voltage option using the right-hand range knob.
2. Press Hot key 3 to change the maximum touch voltage from 50 V to 25 V and back.
3. The instrument will ask if you also want this change to apply to the RCD testing also.
4. Press the green check button (Hot key 4) to accept or the red cross button (Hot key 2) to prevent the change also affecting RCD testing mode.

#### 15.8.3 Auto start test

If this option is on, the operator can press the TEST button to “prime” the auto test mode.

Once the test is primed, the test will start as soon as you connect the test-leads to the live circuit under test. If this option is off, you will need to press the test button to start a Loop Impedance test after connecting the test-leads to a live circuit.

1. Select the AUTO Start Test option on the right-hand range knob.
2. Press Hot key 3 to turn AUTO test start on or off.
3. Your choice is stored automatically.

## 15.9 RCD test settings

1. Select the RCD page from the set-up page.
2. Turn the right-hand knob to highlight the setting you want to change.  
The options allowed are:
  - Allow reverse polarity
  - Maximum touch voltage
  - AUTO start test
  - Ramp test speed
  - Maximum test time  $\frac{1}{2} \times I$
  - Maximum test time  $1 \times I$
  - Auto sequence customisation

### 15.9.1 Allow reverse polarity

This mode allows an RCD test to either prevent or allow a RCD test when it detects a reversed phase and neutral condition.

If this option is on, the instrument will allow RCD tests to continue even if it detects that the live and neutral connections are reversed, but it will still provide a warning. If this option is off, the instrument will inhibit RCD tests if it detects that the live and neutral connections are reversed.

1. Select the allow reverse polarity option using the right-hand range knob.
2. Press Hot key 3 to change the behavior on detecting a reverse L-N connection from allowed ON to allowed OFF. The MFT will state the change will also apply to the Loop Impedance testing. Press green check button (Hot key 4) to accept or red cross (Hot key 2) to decline.
3. Your choice is stored automatically.

### 15.9.2 Maximum touch voltage

1. Select the maximum touch voltage option using the right-hand range knob.
2. Press Hot key 3 to change the maximum touch voltage from 50 V to 25 V and back.
3. The instrument will ask if you also want this change to apply to the Loop Impedance testing also.
4. Press the green check button (Hot key 4) to accept or the red cross button (Hot key 2) to prevent the change also affecting Loop Impedance testing mode.

### 15.9.3 Auto start test

If this option is on, the operator can press the TEST button to “prime” the auto test mode.

Once the test is primed, the test will start as soon as you connect the test-leads to the live circuit under test. If this option is off, you will need to press the test button to start an RCD test after connecting the test-leads to a live circuit.

1. Select the AUTO Start Test option on the right-hand range knob.
2. Press Hot key 3 to turn AUTO test start on or off.
3. Your choice is stored automatically.

### 15.9.4 Ramp test speed

If this option is set to Normal Ramp, the ramp test will run at the standard ramp rate, compliant to IEC 61557-6.

If this option is set to Fast Ramp, the ramp test will run at a faster ramp rate. Although not compliant to IEC 61557-6 this mode is very useful for high current RCD ramp testing without overheating the instrument.

1. Select the Ramp Test Speed option on the right-hand range knob.
2. Press Hot key 3 to switch between Normal Ramp and Fast Ramp.
3. Your choice is stored automatically.

## Instrument settings navigation

### 15.9.5 Maximum test time $\frac{1}{2} \times I$

The maximum test time is the time allowed for the RCD test when tested at half the nominal current. If the RCD trips, the result is a failure. The time can be changed for those RCDs being tested in the UK (1999 ms) and those tested internationally (500 ms).

1. Select the Max Test Time ( $\frac{1}{2} \times I$ ) option using the right-hand range knob.
2. Press Hot key 3 to change the setting between 1999 ms and 500 ms.
3. Your choice is stored automatically.

### 15.9.6 Maximum test time $1 \times I$

The maximum test time is the time allowed for the RCD test when tested at the nominal current. If the RCD fails to trip in the allowed time the result is a failure. The time can be changed for those RCDs being tested to IEC 61008/9 (300 ms) and those tested to older British Standards (200 ms).

1. Select the Max Test Time ( $\frac{1}{2} \times I$ ) option using the right-hand range knob.
2. Press Hot key 3 to change the setting between 300 ms and 200 ms.
3. Your choice is stored automatically.

### 15.9.7 Auto sequence customisation

This option lets you to choose which RCD tests are included in the automatic test sequence.

1. Select the auto sequence customisation option.

The active block is the one highlighted in black.

2. You move around the table by using Hot key 1 (left) and Hot key 5 (right) to highlight the column or row to be disabled or enabled.
3. Repeatedly pressing Hot key 5 will first select the columns in the table moving from left to right before selecting the top row and finally the bottom row.
4. Repeatedly pressing Hot key 1 will reverse the direction.

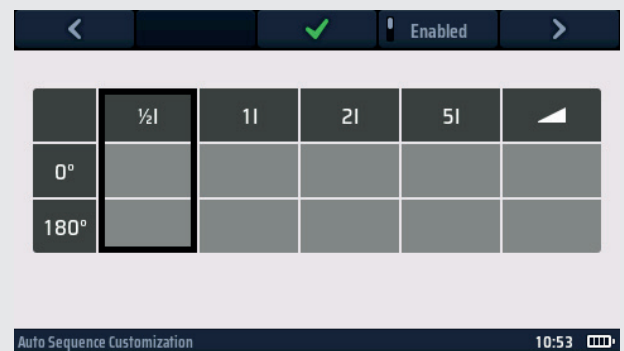

**Fig 57: Auto sequence customisation settings**

5. Press the Enable/Disable button (Hot key 4) to enable or disable the highlighted column or row.
  - You cannot disable 0° and 180° tests at the same time. At least one must remain.
  - You cannot disable all the columns. At least one must remain.
6. When selections are complete press the green check button (Hot key 3) to accept store your selections.
7. The RCD Auto test sequence will now display the new combination of tests you have selected.

### 15.10 Instrument information

1. Select the Inst (instrument information) page using the right rotary knob.
2. The screen will show:

|                             |   |
|-----------------------------|---|
| <b>GUI Version:</b>         | the firmware version for the GUI (user interface) |
| <b>Measurement Version:</b> | the firmware version for the measurement system   |
| <b>Date of calibration:</b> | the date the instrument was last calibrated       |
| <b>Serial Number:</b>       | the unique serial number for the instrument       |
| <b>Model Number:</b>        | the name of the instrument                        |

3. None of the settings above can be changed by the operator. They are for reference only.

## 16. Download results to a remote device

The instrument can be connected to a range of remote devices for receiving the test results and passing them to the cloud-based Megger CertSuite™ software. They are:

- Android phones and tablets
- Apple iOS® phones and tablets

Each result can be transferred from the instrument to a mobile device running CertSuite™, from which they are automatically transferred to the cloud if a network is available, or immediately a mobile network is detected if not available at that time.

Test results on the mobile device are synchronized with the cloud system every 90 seconds to reduce any risk of data loss from the mobile device.

A summary of the installation sequence is:

1. Create a CertSuite™ account on the CertSuite™ web site. **Refer to 16.1 Creating a CertSuite™ account on page 93.**
2. Install CertSuite™ on your mobile device. **Refer to 16.2 Installing CertSuite™ on a mobile device on page 93.**
3. Switch on the Bluetooth® mode on the MFT-X1. Select Settings > Network Connection and press Hot Key 3 to change setting to ON (**Refer to 15.5.11 Network connection on page 87.**)
4. Log into your CertSuite™ application on your mobile device using your account details from (1) above.
5. Connect CertSuite™ to your MFT-X1.

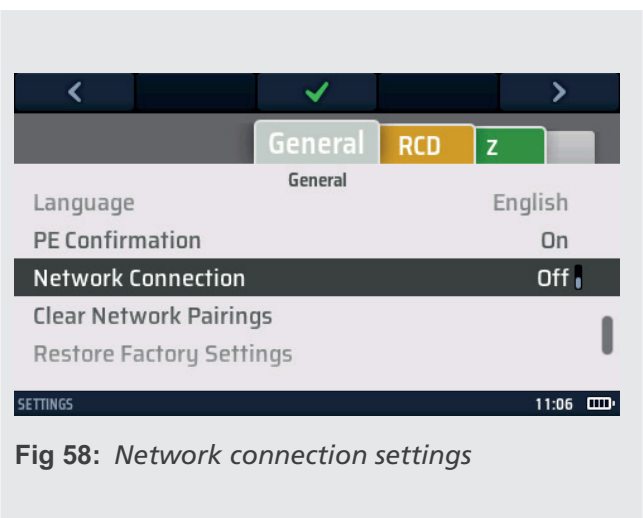

Fig 58: Network connection settings

**NOTE :** The MFT-X1 does NOT need to be connected to a mobile device. The CertSuite™ software should find the instrument if the MFT-X1 and mobile device Bluetooth® are active.

### 16.1 Creating a CertSuite™ account

Before CertSuite™ can be used an account has to be created. This can be done by going to [www.CertSuite.info](http://www.CertSuite.info) and select the **FREE TRIAL** option. Follow the guidance on the CertSuite™ web site.

Keep a record of your account information and password as you will need this when using CertSuite™ on mobile devices.

If necessary, any assistance can be accessed through the CertSuite™ ([www.CertSuite.info](http://www.CertSuite.info)) or Megger web sites ([www.megger.com](http://www.megger.com)) and Megger technical support ([uksupport@megger.com](mailto:uksupport@megger.com)).

### 16.2 Installing CertSuite™ on a mobile device

CertSuite™ can be installed from the relevant Android or IOS store. Use these links to take you to CertSuite download page →  
CertSuite™ requires typically 34 Mb of memory space.

The software has a free one-month trial period.

Follow your normal installation process for either platform.

Once installed on the mobile device, follow the installation process

in the software. Assistance and guidance are available at: [www.CertSuite.info](http://www.CertSuite.info)

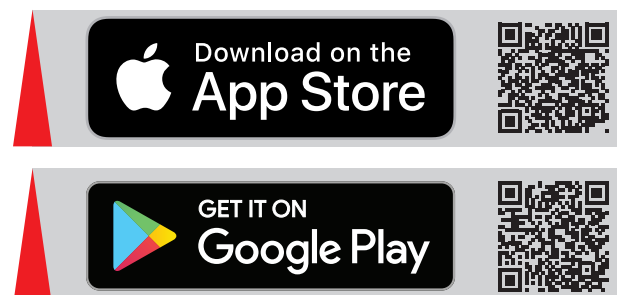

## 16.3 Switching on the MFT-X1 Bluetooth® mode

1. Turn the left rotary knob to the settings option
2. Select the network connection option on the MFT-X1 in Settings options under the General tab.
3. Press the green check button (Hot key 3) to turn the network connection on. A Bluetooth® icon should start flashing in the info bar at the bottom of the MFT display. This indicates the MFT is broadcasting its identity using Bluetooth® and can be found by remote devices.



Fig 59: Flashing Bluetooth® icon

**NOTE :** Press Hot key 3 again to turn network connection off if required. Switching off the Bluetooth® mode will prevent test results from being sent to mobile devices.

4. Exit Settings mode. Your settings are stored automatically.

## 16.4 Connecting to the MFT-X1 from CertSuite™

The MFT-X1 needs to connect with the CertSuite™ application. This is done from the CertSuite™ application on the mobile device. Ensure your mobile device has Bluetooth® activated.

**NOTE :** The MFT-X1 does NOT need to be paired to a mobile device.

1. Ensure your mobile device has a network connection, either by phone or WIFI to the CertSuite™ cloud application.
2. Open CertSuite™ on your mobile device and log into your CertSuite™ account.
3. CertSuite™ will display a red dropdown box.
4. Press the down arrow and a list of the available MFTs will appear. These are the MFTs in Bluetooth® range that have Bluetooth® active.
5. The MFT models and serial numbers are shown. Select the required MFT from the list.

**NOTE :** To ensure the correct MFT is being connected, the serial number of the MFT can be found in the settings option under the Inst tab on the instrument.

The MFT drop down box should turn green acknowledging the connection has been made to the MFT-X1. This may take a few seconds.

The Bluetooth® icon in the information bar at the bottom of the display should change from flashing and become permanently on, as below:



**Fig 60:** *Permanently ON*

Connection between the MFT-X1 and CertSuite™ is complete.

## 16.5 Failure to connect

If the MFT-X1 fails to connect to the mobile device check the following:

- The MFT-X1 serial number matches that on the instrument
- Mobile device Bluetooth® is active
- MFT-X1 Bluetooth® icon is flashing
- The mobile device can see the MFT-X1 in the available device listing
- The MFT is close to the mobile device (for connection purposes)

If the instrument fails to connect to the mobile platform, contact Megger Technical Services for assistance or contact the CertSuite team via the web site: [CertSuite.info](http://CertSuite.info).

## 16.6 Sleep mode and power cycling the MFT-X1

The MFT-X1 can drop into a sleep mode after 5 minutes or longer depending on the time set in the general settings on the instrument. If this happens the connection to the MFT-X1 will be lost.

Likewise, if the Instrument is turned off the connection will be lost.

In both cases the green MFT Icon in the CertSuite™ application will turn red, indicating loss of connection.

The Bluetooth® icon on the MFT Information bar will also start flashing.

In sleep mode, pressing the test button on the instrument will wake it and automatically re-connect to the mobile device.

The same applies to the power off function. Switching the unit back on should automatically reconnect the Instrument to the mobile device.

Should the reconnection fail then press the down arrow on the red icon in CertSuite™, select the instrument from the list and the instrument should re-connect.

## 16.7 Sending test results to CertSuite™

Once the MFT-X1 and CertSuite™ are connected, results can be transferred to the mobile device. Most results will be sent to the circuits tab in the **Schedule of Test** page in CertSuite™.

If necessary, follow guidance on the CertSuite™ website [CertSuite.info](http://www.CertSuite.info) to learn how to use CertSuite™ and access the **Schedule of Test** page.

To send a result follow the example below:

1. Open a **Schedule of Test** in the CertSuite™ application.
2. Choose a test type in the MFT-X1 (initially an insulation test is a good example).
3. Perform the test normally on the instrument, as explained in the insulation test section above.
4. On successful completion of the test the help icon (Hot key 3) in the display will change to the save icon ().
5. Press Hot key 3 to initiate the send process. The instrument will show some wheels in the right hand side of the display. These allow the user to allocate some tags to control where the result appears in the CertSuite™ page.
6. Navigate between the wheels using the left and right buttons (Hot keys 1 and 5).  
Use the right range knob to select the required option within each of the wheels.  
The wheel settings need to state the location where the result needs to appear in the schedule.  
**Example:** For the insulation test result to appear in circuit 1, on Phase 1 and was tested between phase and Earth, select the following:
  - Left Wheel – Select the circuit number (eg 1)
  - Centre wheel – Select the phase being tested (eg L1)
  - Right wheel – Select the measurement type (eg L-PE)
7. When complete press the green check Hot key (Hot key 3) to send the result.
8. The MFT-X1 will acknowledge a successful send and CertSuite™ should show a green bar through circuit 1L1, indicating a value has been received.
9. The value should appear in the L-PE column as selected on the instrument.
10. If the value is replacing an existing value, CertSuite™ will display an MFT confirm page and ask for confirmation to over-write the existing value.

**NOTE :** Once a result has been sent to CertSuite™ the send option on the MFT is removed.

## 16.8 Re-sending test results to CertSuite™

If the test result that have been entered into the schedule needs to be changed the measurement can be repeated and re-sent to the same location in the schedule.

In this case CertSuite™ will warn that a saved value is being over-written and ask for permission.

Only one value can be entered into a single location in CertSuite™.

## 16.9 Further CertSuite information and support

Further information on how to use CertSuite™ is available from the website:

[www.CertSuite.info](http://www.CertSuite.info)



## 17. Updating the operating system

The operating system (OS) is the heart of the instrument and can now be updated by the end user without the need to return the instrument to Megger or an approved repair centre.

There are several reasons for updating the OS. They include:

- Feature or functional upgrades or additions
- To maintain alignment with electrical test standards
- Fixing issues or bugs within the operating system
- To enhance safety of the product

Updates are possible when an update is available from the Megger web site, or when advised to do so by Megger Technical Support staff.

To get access to the instrument updates you need to register your instrument on the Megger website:

[www.megger.com/register](http://www.megger.com/register)

**NOTE :** Operating system updates do NOT over-write the calibration constants stored in the instrument.

### 17.1 To update your instrument operating system:

The update process installs the new OS from a microSD card. It is important to use a blank microSD card for this purpose.

The microSD card **MUST** be removed after the update has been completed, or the instrument will try to install the update again.

**NOTE :** Minimum recommended microSD card size is 4 Gb and the Maximum card size is 32 Gb.

**NOTE :** The card must be formatted to the FAT32 format and must be blank.

#### 17.1.1 Download the latest operating system onto microSD card

1. Go to the SOFTWARE page for the MFT-X1. (visit: [www.megger.com/mft-x1](http://www.megger.com/mft-x1)) or scan the QR code ↓



2. Locate the latest MFT-X1 update ZIP file under the **SOFTWARE** section of the website page. Click to download.
3. Unzip this file to your SD card. It contains the instructions for updating the operating system and the required .BIN file.
4. Check the version on the SD card is later than the version installed in the instrument. The version on the instrument can be found in Settings > INST > GUI version.





**NOTE : Recommended microSD card format:      FAT32**

**NOTE : Maximum microSD card size:              32 Gb**

## Updating the operating system

### 17.1.2 Installing the latest operating system to your instrument

Before updating the instrument operating system ensure there is at least 50% battery charge. If battery status is low recharge or replace the battery before updating the instrument.

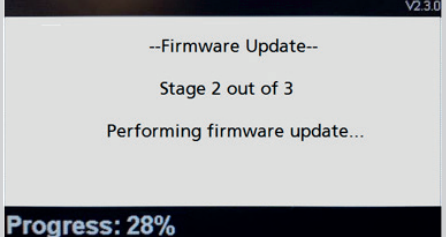
|  |   |
|--|---|
| 1. Turn the left-hand rotary knob to the off position.   |   |
| 2. Disconnect and unplug any test-leads.   |   |
| 3. Remove the battery pack.  |    |
| 4. Remove the fuse cover in the base of the battery compartment.   |    |
| <p>5. Install the new microSD card (with the latest operating system .BIN file), observing the correct orientation. The card should click into place.</p> <p><b>NOTE :</b> The microSD card is inserted into a spring loaded socket</p> <p>The first press should engage the card.<br/>The second press should release the card.<br/>DO NOT force the card into the slot.</p> <p>Always check correct orientation of the card in the SD slot as shown on the image and <b>Refer to 18.3.1 Battery and fuse assembly on page 102.</b></p> |   |
| <p>6. Replace the fuse cover and secure in place.</p> <p>7. Reinstall the battery pack.</p> <p>8. Switch on the instrument.</p> <p>9. The instrument will display an advisory screen as below, indicating the new file has been located and ready to be used:</p>  |  |
| <p><b>CAUTION : Ensure the instrument has at least 50% charge remaining before attempting to update the operating system</b></p>   |   |
| 10. Press one of the TEST buttons to start the update process.   |   |
| <p><b>CAUTION : Do not switch off the instrument during the update process.</b></p>  |   |
| <p>The update process is fully automated. No user intervention is required.</p>  |  |

There are two phases to the software update:

### Phase 1: Operating system update

**Stage 1** – Preparing to install software

**Stage 2** – Performing firmware update

**Stage 3** – Updating FSM

### Phase 2:

**Stage 4** – Measurement system update

1. At the end of the update the display will show the update has successfully finished and ask you to turn off the instrument.
2. Remove the battery pack and fuse cover.
3. Remove the microSD card. If the SD card is left in, switching on the instrument will re-start the update process.
4. Replace the fuse cover and battery pack.
5. Switch on the instrument.
6. Turn the left-hand rotary knob to **Settings**. Select the Inst. tab and check the GUI and Measurement version numbers have been updated to the latest firmware. The latest firmware version number can be found at [megger.com/mft-x1](http://megger.com/mft-x1)
7. The instrument is now ready to use.



## Updating the operating system

### 17.1.3 System update – Error messages

Errors may occur if:

- There is more than one operating system file on the microSD card
- There is an error in the updating process

In such cases the update process will stop and warn the user.

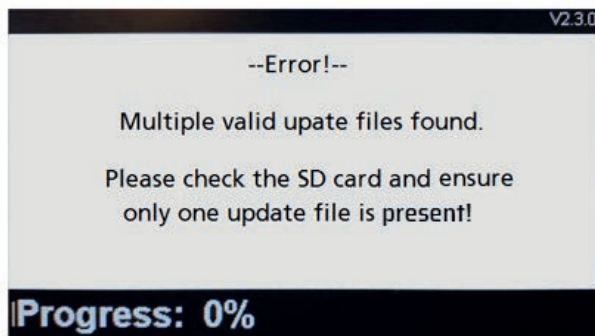

**Fig 61:** Example Error screen

In such cases the update process will stop and warn the user. Ensure the microSD card only has the latest operating system .BIN file in the root directory.

Download the update .BIN file from the Megger website and replace the existing file.

Re-run the update process.

If the update process continues to fail, contact Megger technical support:

**[uksupport@megger.com](mailto:uksupport@megger.com)** or **+44 (0) 1304 502 102**

### 17.1.4 Error during the automatic update process:

If the operating system has begun the update process the update will be stopped.

Switch the instrument Off and On to restart the update process.

If the instrument fails again, switch off the instrument and remove the microSD card.

Replace the update .BIN file with the previous version of the operating system on the microSD card

Repeat the update process to restore the original operating system.

Contact Megger technical support:

**[uksupport@megger.com](mailto:uksupport@megger.com)** or **+44 (0) 1304 502 102**

## 18. Service and maintenance

---

### 18.1 General maintenance

- Test-leads should be checked before each use for damage and continuity.
- Ensure the unit is kept clean and dry after use.
- Remove batteries from the instrument if the unit is being stored for extended periods.

### 18.2 Cleaning

- Disconnect the test leads from the instrument.
- Dirty leads should be cleaned with a clean cloth dampened with either water or isopropyl alcohol (IPA).
- Wipe the instrument with a clean cloth dampened with either water or isopropyl alcohol (IPA).
- Wipe the leads and instrument using a clean, dry cloth to remove excess liquid.

### 18.3 Batteries and battery replacement

**WARNING : Only the custom Megger Li-ion battery pack can be used in this instrument.**

**WARNING : Always switch off the instrument and remove the test-leads before the battery module is removed or installed.**

The MFT-X1 will be supplied with a Lithium-ion battery pack and a charger.

**CAUTION : Old batteries must be disposed of in accordance with local regulations.**

**CAUTION : Only use approved batteries as defined in 18.3.1.**

**CAUTION : Battery cells should not be left in the instrument if remaining unused for an extended period.**

18.3.1 Battery and fuse assembly

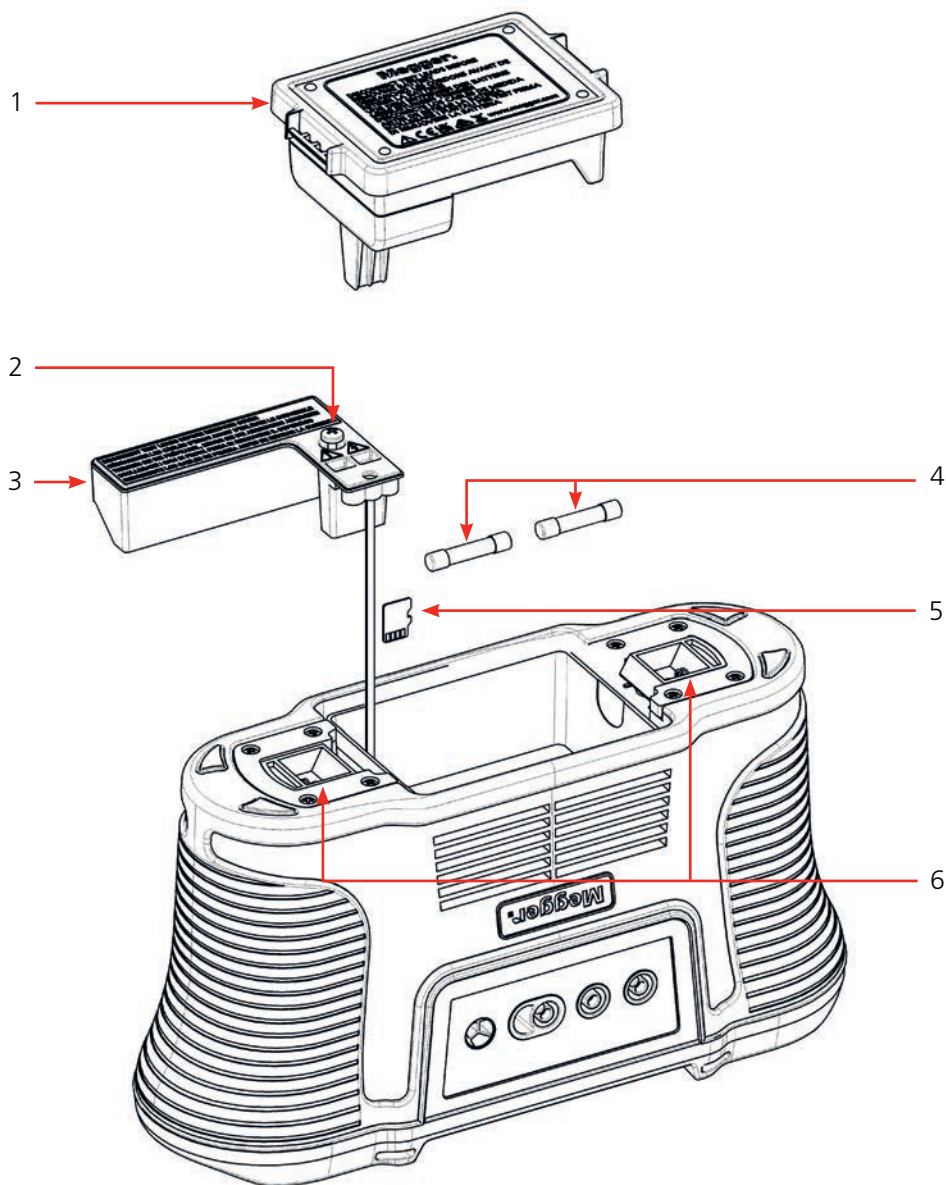

| Item | Description                    | Item | Description           |
|------|--------------------------------|------|-----------------------|
| 1    | Li-ion battery pack            | 4    | 2 x Fuses             |
| 2    | Removable internal cover screw | 5    | MicroSD card          |
| 3    | Removable internal cover       | 6    | Spring loaded catches |
|      |                                |      |                       |

Replacement battery types are:

- Megger custom Li-ion battery module

### 18.3.2 Battery status

The battery condition icon is located at the bottom right corner of the display. This icon is always displayed when the MFT-X1 is switched on. When the instrument is on, the icon will indicate the state of charge.

The MFT-X1 battery status:

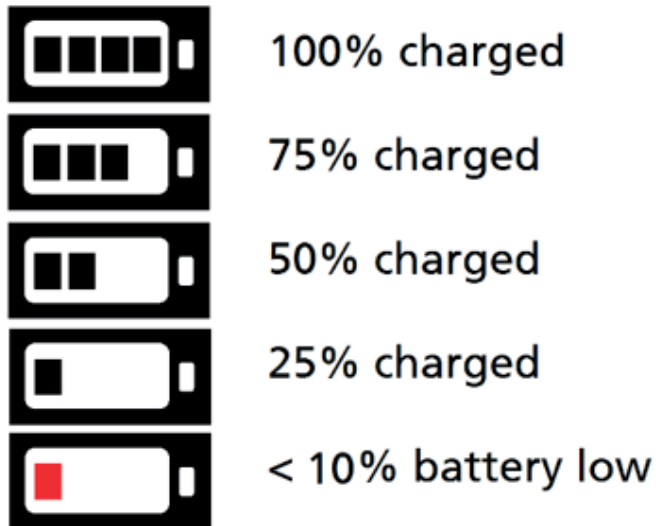

When the battery is very low the last battery cell will turn red. Tests can be prevented in this state. The battery needs to be recharged.

**NOTE :** The time and date stamp and changes to the settings and testing modes are maintained by a Lithium coin cell and will not need re-setting when the battery is removed.

**NOTE :** Some tests draw significantly more power than others. Under low battery levels some tests may be inhibited, such as Insulation testing, when others may still function, such as voltage measurement.

### 18.3.3 Lithium-ion battery pack – removal and replacement

The battery pack will need charging before you use it for the first time. It is charged outside the instrument.

**WARNING : The Megger Li-ion battery pack must ONLY be charged using the approved Megger battery charger MBC2100. These chargers are regulated for the Megger battery pack with internal charge control and thermal protection. Using any other charger can be dangerous and may damage the battery.**

**The battery pack must be removed from the instrument for charging.**

No tools are needed to remove the battery pack from the instrument.

To remove and replace the pack:

1. Turn the left-hand rotary knob to the off position.
2. Disconnect the test-leads from the instrument.
3. Pull apart the two spring loaded catches on the bottom of the instrument. The battery pack will pop up slightly and is now free to remove.
4. Charge the battery pack with the MBC2100 battery charger.
5. When charged, insert the battery pack into the instrument and push the battery pack fully home. The retaining clips will automatically click into place.

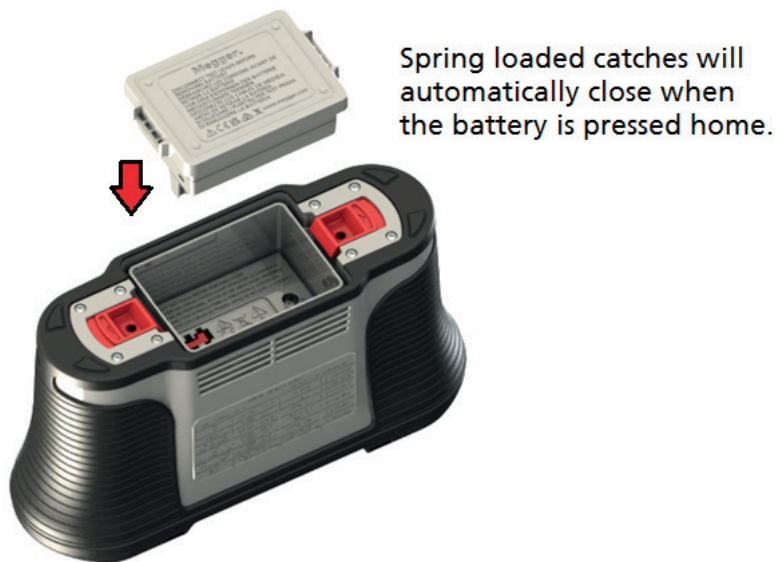

Fig 62: Battery insertion



### 18.3.4 Lithium-ion battery pack – charging

The battery packs and the charger both have LEDs to indicate charging status.



Full charge will take between 2–3 hours for a full charge, depending on ambient temperature.

A 30 minute charge should provide approximately half a day of battery life.

Temperatures above 30°C (85°F) will slow the charging process as heat is not so easily dissipated from the batteries.

The temperature limit for charging the Li-ion battery is 40°C (104°F). Above 40°C the charger pack will stop and the battery pack will show a RED warning LED.

#### Battery charging status indicators:

| Charger pack | Li-ion battery pack   | Charging status   |
|--------------|---|---|
| No LED       | No LED  | Battery pack is not charging  |
| Red LED      | Green LED  | Connected and charging  |
| Green LED    | Green LED  | Charged (in trickle mode charge)                                    |
| Green LED    | Red LED   | Indicates the ambient temperature is too high to charge the battery |

#### Li-ion battery pack charging status indicators:

**NOTE :** When the LED on the Li-ion battery pack is green it does not mean that it is charged. A green LED on the charger pack shows that the battery is fully charged.

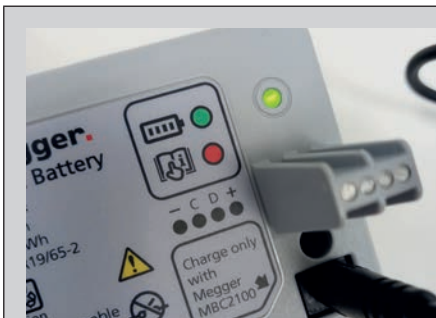

Fig 63: Battery pack connected



Fig 64: Charger pack charging

## 18.4 Battery disposal

Refer to 22. Decommissioning on page 114.

## 18.5 Fuse and fuse replacement

**WARNING : Only use the recommended ceramic-body HRC fuse. Refer to the specification for details. Glass fuses are dangerous and must not be used.**

Your MFT-X1 incorporates replaceable fuses. This is an important safety feature that protects the instrument and the user. The fuse will blow only in rare circumstances but if you need to replace it the following warning will be displayed:

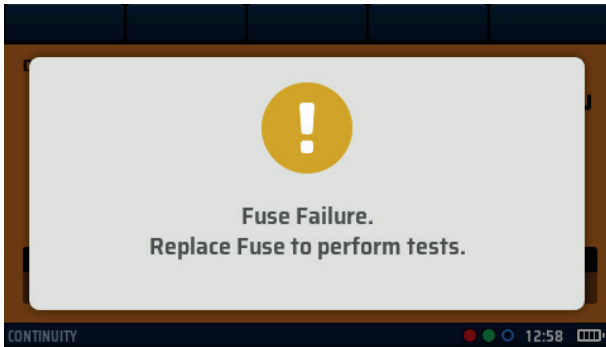

**Fig 65:** Fuse fail warning

To replace a fuse, **Refer to 18.3.1 Battery and fuse assembly on page 102.** as a guide to fuse location.

1. Turn the left-hand rotary knob to the off position.
2. Disconnect and unplug the test-leads.
3. Release the two spring loaded catches on the bottom of the instrument.



4. Remove the battery pack.



5. Undo the screw in the base of the battery compartment.
6. Remove the fuse cover in the base of the battery compartment.



7. Replace the blown fuse with a new fuse of the correct type as stated in the specification.
8. Refit the fuse cover.
9. Reinstall the battery pack.



## 19. Specifications

### Voltage measurement

| Function        | Range                              | Accuracy   |
|-----------------|------------------------------------|--|
| Voltage DC      | 0 V to $\pm 1000$ V                | $\pm 1\%$ $\pm 3$ digits                               |
| Voltage AC/TRMS | 0 V to 600 V (15 to 500 Hz)        | $\pm 2\%$ $\pm 1$ digits                               |
| Frequency       | 15 Hz to 99 Hz<br>100 Hz to 500 Hz | $\pm 0.5\%$ $\pm 2$ digit<br>$\pm 2.0\%$ $\pm 2$ digit |
|                 |                                    |  |

### Millivolt measurement

| Function   | Range                                 | Accuracy                 |
|------------|---------------------------------------|--------------------------|
| mV AC/TRMS | 0 mV to $\pm 1999$ mV<br>(50 / 60 Hz) | $\pm 1\%$ $\pm 3$ digits |
| mV DC      | 0 mV to $\pm 1999$ mV                 | $\pm 1\%$ $\pm 3$ digits |

### Live Earth detection

Indicates if the PE terminal is live when selecting the Loop or RCD test ranges.  
The relevant Loop or RCD test is inhibited.

### Current

| Function               | Range                         | Accuracy                 |
|------------------------|-------------------------------|--------------------------|
| Current AC/TRMS        | 0.001 A to 0.100 A            | $\pm 2\%$ $\pm 3$ digits |
|                        | 0.100 A to 2.000 A            | $\pm 2\%$ $\pm 3$ digits |
|                        | 2.00 A to 20.00 A             | $\pm 2\%$ $\pm 3$ digits |
|                        | 20.0 A to 300.0 A             | $\pm 2\%$ $\pm 3$ digits |
| Frequency bandwidth    | 15 Hz to 500 Hz               |                          |
| Influence of frequency | 30 Hz to 500 Hz $\leq 0.25\%$ |                          |
|                        |                               |                          |

### Resistance and Continuity

| Function             | Range                          | Test Current                                  | Accuracy                 |
|----------------------|--------------------------------|---|--------------------------|
| 200 mA               | 0.01 $\Omega$ to 99.9 $\Omega$ | (0 $\Omega$ to 2 $\Omega$ ) 205 mA $\pm 5$ mA | $\pm 3\%$ $\pm 2$ digits |
| 10 mA                | 0.01 $\Omega$ to 99.9 $\Omega$ | 10 mA   | $\pm 3\%$ $\pm 2$ digits |
|                      | 100 $\Omega$ to 999 k $\Omega$ |   | $\pm 5\%$ $\pm 2$ digits |
| Open circuit voltage | 4 V to 5 V                     |   |                          |
|                      |                                |   |                          |

**EN 61557-4 Measurement Range:** 0.10  $\Omega$  to 999 k $\Omega$ .

## Specifications

### Insulation test

| Function              | Range  | Accuracy      |
|-----------------------|--|---------------|
| 1000 V                | 0.001 to 999 MΩ                                | ±3% ±2 digits |
| 500 V                 | 0.001 to 500 MΩ                                | ±3% ±2 digits |
|                       | > 500 MΩ                                       | ±10%          |
| 250 V                 | 0.001 to 250 MΩ                                | ±3% ±2 digits |
|                       | > 250 MΩ                                       | ±10%          |
| 100 V                 | 0.001 to 100 MΩ                                | ±3% ±2 digits |
|                       | > 100 MΩ                                       | ±10%          |
| 50 V                  | 0.001 to 50 MΩ                                 | ±3% ±2 digits |
|                       | > 50 MΩ  | ±10%          |
| VAR                   | Leakage current > 1 mA                         | ±3% ±2 digits |
| 50 V to 999 V         | Leakage current < 1 mA                         | ±10%          |
| Leakage current       | 0.1 μA to 1.99 mA                              | ±10%          |
| Output voltage        | -0%, +2%, +2 V at rated load or less           |               |
| Voltage display       | ±1% ± 3 V                                      |               |
| Short circuit current | 1.5 mA nominal                                 |               |
| Test current on load  | 1 mA at min pass values of insulation          |               |
| Maximum capacitance   | 2 μF for a stable reading, 5 μF absolute limit |               |

**EN 61557-2 Measurement Range:** 0.10 MΩ to 999 MΩ.

### Loop 2 wire – No RCD (L-PE, L-N or L-L)

| Function         | Range            | Accuracy       |
|------------------|------------------|----------------|
| 2 wire HR        | 0.001 to 9.999   | ±2% ±0.030 Ω   |
| 2 wire           | 0.01 Ω to 9.99 Ω | ±2% ±5 digits  |
|                  | 10.0 Ω to 99.9 Ω | ±10% ±5 digits |
|                  | 100 Ω to 1999 Ω  | ±10% ±5 digits |
| Supply voltage   | 48 V to 550 V    |                |
| Supply frequency | 45 Hz to 65 Hz   |                |

Can be used to measure supply source resistance quickly and reliably between Line and PE or two Live conductors up to 550 V.

**EN 61557-3 Measurement Range:** 0.30 Ω to 1999 Ω

### Loop 2 wire L-PE with RCD

| Function         | Range            | Accuracy       |
|------------------|------------------|----------------|
|                  | 0.01 Ω to 1999 Ω | ±10% ±5 digits |
| Supply voltage   | 48 V to 280 V    |                |
| Supply frequency | 45 Hz to 65 Hz   |                |

**NOTE :** Uses the Megger Confidence Meter to measure the supply source impedance of circuits protected with an RCD rated  $\geq 30$  mA when there are only two connections possible. When a neutral is available the three-wire test will provide a quicker, more accurate result.

**NOTE :** RCD may trip if there are high leakage currents in the circuit under test. This measurement is immune to the effect of inductance found in some RCDs as it measures resistance (RCD Uplift).

**EN 61557-3 Measurement Range:** 1.00 Ω to 1999 Ω

**Loop 3 wire L-PE with RCD**

| Designation | Test Current | Application  |
|-------------|--------------|--|
| RCD         | 15 mA        | For circuits protected by an RCD rated $\leq 30$ mA                            |
| RDC EV      | 3 mA         | For EV charger circuits protected by a RDC and a Type A RCD rated $\leq 30$ mA |
|             |              |  |

| Function         | Range                           | Accuracy                  |
|------------------|---------------------------------|---------------------------|
|                  | 0.01 $\Omega$ to 9.99 $\Omega$  | $\pm 2\%$ $\pm 5$ digits  |
|                  | 10.0 $\Omega$ to 199 9 $\Omega$ | $\pm 10\%$ $\pm 5$ digits |
| Supply voltage   | 48 V to 280 V                   |                           |
| Supply frequency | 45 Hz to 65 Hz                  |                           |
|                  |                                 |                           |

**NOTE :** Uses the Megger Confidence Meter to measure the supply source impedance of circuits protected with an RCD when three connections are possible. The L-N Loop resistance needs to be less than 12  $\Omega$ .

The resistances of the L-PE, L-N and N-PE loops are all shown, and the accuracy of the L-PE resistance depends on the maximum resistance displayed. When the neutral is not available the two-wire test must be used.

**NOTE :** RCD may trip if there are high leakage currents in the circuit under test. This measurement is immune to the effect of inductance found in some RCDs as it measures resistance.

**EN 61557-3 Measurement Range:** 1.00  $\Omega$  to 1999  $\Omega$

**RCD Tests****Types A and AC**

|   |  |
|---|--|
| RCD types                                   | AC, A, AC(S), A(S)   |
| RCD rated current ( $I_{\Delta n}$ )        | 10 mA, 30 mA, 100 mA, 300 mA, 500 mA, 650 mA, 1000 mA, VAR |
| $\frac{1}{2}$ I no-trip test current        | -10% to +0% 0.5 $I_{\Delta n}$                             |
| 1 I, 2 I, 5 I trip test – AC current        | -0% to +10% $M \cdot I_{\Delta n}$                         |
| 1 I, 2 I, 5 I trip test – pulsed DC current | -0% to +10% 1.4 $\cdot M \cdot I_{\Delta n}$               |
| Trip time                                   | $\pm 10\%$   |
| Ramp trip test current                      | $\pm 5\%$  |
| Fault voltage (0 V – supply)                | +5% +15% $\pm 0.5$ V                                       |
| Supply voltage                              | 48 V to 280 V  |
| Supply frequency                            | 45 Hz to 65 Hz   |
|   |  |

**Type B**

|                                      |                                   |
|--------------------------------------|-----------------------------------|
| RCD types                            | B, B(S)                           |
| RCD rated current ( $I_{\Delta n}$ ) | 10 mA, 30 mA, 100 mA, 300 mA      |
| $\frac{1}{2}$ I no-trip test current | -10% to +0% (0.5 $I_{\Delta n}$ ) |
| 1 I, 2 I, 5 I trip test current      | -0% to +10% (2 $I_{\Delta n}$ )   |
| Trip time                            | $\pm 10\%$                        |
| Trip current (ramp)                  | $\pm 5\%$                         |
| Fault voltage (0 V – supply)         | +5% +15% $\pm 0.5$ V              |
| Supply voltage                       | 48 V to 280 V                     |
| Supply frequency                     | 45 Hz to 65 Hz                    |
|                                      |                                   |

## Specifications

### RDC (Type EV) with a 30 mA Type A RCD

|                              |  |
|------------------------------|--|
| Test current                 | 2.0 mA increasing to 6.3 mA, before being held at that current for 10 s. |
| Trip time                    | ±1% ±1 ms  |
| Trip current (ramp)          | ±5%  |
| Fault voltage (0 V – supply) | +5%, +15%, ±0.5 V  |
| Supply voltage               | 48 V to 280 V  |
| Supply frequency             | 45 Hz to 65 Hz   |

### Earth

| Function       | Range            | Accuracy      |
|----------------|------------------|---------------|
| 2 wire test    | 0.01 Ω to 1999 Ω | ±2% ±3 digits |
| Test frequency | 128 Hz           |               |
| Test current   | 25 V, 4.5 mA     |               |

**NOTE :** The 2 wire earth test measures resistance between the blue and green terminals using a 128 Hz square wave; the result includes the resistance of test leads.

**EN 61557-5 Measurement Range:** 1 Ω to 1999 Ω.

| Function                               | Range                              | Accuracy      |
|--|------------------------------------|---------------|
| 3 wire test                            | 0.01 Ω to 1999 Ω                   | ±2% ±3 digits |
| Test frequency                         | 128 Hz                             |               |
| Test current                           | 25 V, 4.5 mA / 50 V, 450 μA        |               |
| Maximum auxiliary electrode resistance | 5 kΩ for 25V<br>or 100 kΩ for 50 V |               |

### Power supply

|                          |  |
|--------------------------|--|
| Li-ion rechargeable      | 7.2 V DC 4400 mAh (non-serviceable) + charge status indication   |
| Battery charger (Li-ion) | Input: 110 V / 230 V AC, 50/60Hz, 1.3 A<br>Output: 3 A, 8.4 V DC   |
| Battery life             | Li-ion: 4400 mAh = >15 hrs*<br><b>Continuity:</b> Approximately 2000 tests using Li-ion battery (0.5s test every 30s per EN 61557)<br><b>Insulation:</b> Approximately 1400 tests using Li-ion battery (0.5s test every 30s per EN 61557)<br><b>Earth:</b> Approximately 1600 tests using Li-ion battery<br>*times based on typical daily test profile |
| Battery charging time    | Li-ion: 2.5 to 3 hrs (ambient temperature dependent)   |

**Environmental**

| Conditions              | Range   |
|-------------------------|---|
| Operating temperature   | -10 °C to +55 °C  |
| Storage temperature     | -25 °C to +70 °C  |
| Operating humidity      | 90% R.H. at +40 °C max  |
| Ingress protection      | IEC 60529: IP 54<br>Equipment is protected against ingress of dust and water splashes and is suitable for indoor and outdoor use. |
| Vibration               | MIL-PRF-28800F: class 2   |
| Max. operating altitude | 2000 m  |
| Pollution degree        | 2   |
|                         |   |

**Mechanical**

|                          |                   |
|--------------------------|-------------------|
| Length                   | 274 mm (10.79 ")  |
| Width                    | 96 mm (3.78 ")    |
| Depth                    | 143 mm (5.63 ")   |
| Weight (instrument only) | 1.57 kg (3.46 lb) |
| Shipping weight          | 5.6 kg (12.35 lb) |
|                          |                   |

## 20. Accessories and equipment

### 20.1 Included accessories

| Item  | Order No. |
|---|-----------|
| MFT-X1-BS Multifunction tester BS1363           | 1012-223  |
| MFT-X1-SC Multifunction tester Schuko           | 1012-225  |
| MFT-X1-CH Multifunction tester Switzerland      | 1012-229  |
| MFT-X1-AU Multifunction tester AUS/NZ           | 1012-230  |
| Switched test probe SP5                         | 1002-774  |
| Red test lead, probes, clips and grabbers       | 1013-455  |
| Blue test lead, probe, clips and grabbers       | 1013-456  |
| Green test lead, probe, clips and grabbers      | 1013-457  |
| Earth test spike and leads kit                  | 1001-810  |
| Li-ion battery 4400 mAh                         | 1013-450  |
| Li-ion battery charger                          | 1013-451  |
| SIA10 MAINS socket interface adaptor UK (boxed) | 1014-300  |
| Neck strap                                      | 1013-454  |
| Multipurpose hard base carry case               | 1014-985  |
| Quick start guide                               |           |
| Calibration certificate                         |           |

### 20.2 Optional accessories

| Item  | Order No. |
|---|-----------|
| SIA20 Mains socket interface adaptor AU               | 1007-170  |
| SIA40 Mains socket interface adaptor SCHUKO           | 1007-171  |
| SIA45 Bipolar mains socket interface adaptor SCHUKO   | 1007-158  |
| SIA50 Mains socket interface adaptor CH               | 1007-164  |
| SIA60 Mains socket interface adaptor USA              | 1007-087  |
| Blow molded carry case (Polypropylene)                | 1013-453  |
| 3 lead set RD/GN/BU non-fused (boxed)                 | 1014-291  |
| 3 lead pro set RD/GN/BU non-fused (boxed)             | 1014-292  |
| 3 lead set RD/GN/BU fused 10 A (boxed)                | 1014-295  |
| 3 piece grabber set RD/GN/BU (boxed)                  | 1014-299  |
| 7 piece probe and clip set RD/GN/BU (boxed)           | 1014-301  |
| 3 lead RD/GN/BU fused 10 A (boxed) – fused leads only | 1014-304  |
| MCC1010 Current clamp                                 | 1010-516  |
| MVC1010 Voltage clamp                                 | 1010-518  |
| MSA1363 Socket adaptor UK                             | 1013-837  |
| MTF230 – Schuko (Type-F) socket adaptor               | 1013-838  |
| LA-KIT Lamp adaptor kit                               | 1014-833  |
| UKAS Calibration certificate                          | 1013-460  |



## 21. Calibration, Repair and Warranty

Megger operate fully traceable calibration and repair facilities to make sure your instrument continues to provide the high standard of performance and workmanship that is expected. These facilities are complemented by a worldwide network of approved repair and calibration companies, which offer excellent in-service care for your Megger products.

For service requirements for Megger instruments contact:

### Megger Limited

Archcliffe Road

Dover

Kent

CT17 9EN

**U.K.**

Tel: +44 (0) 1304 502 243

Fax: +44 (0) 1304 207 342

### 21.1 Return procedure

**WARNING : DO NOT remove the battery cells before shipping this instrument. The MFT-X1 can only be shipped via land or sea freight with the Lithium-ion batteries installed. The MFT-X1 cannot be shipped by Air freight. Faulty battery modules MUST NOT be shipped to Megger or anywhere else.**

#### UK Service Centre

1. When an instrument requires recalibration, or in the event of a repair being necessary, a Returns Authorisation (RA) number must first be obtained from one of the addresses shown above. The following information is to be provided to enable the Service Department to prepare in advance for receipt of your instrument and to provide the best possible service to you:
  - Model (for example, MFT-X1).
  - Serial number (found on the display under settings, device information, or on the rear cover and by the battery or on the calibration certificate).
  - Reason for return (for example, calibration required, or repair).
  - Details of the fault if the instrument is to be repaired.
2. Make a note of the RA number. A returns label can be emailed or faxed to you if required.
3. Pack the instrument carefully to prevent damage in transit.
4. Before the instrument is sent to Megger, freight paid, make sure that the returns label is attached or that the RA number is clearly marked on the outside of the package and on any correspondence. Copies of the original purchase invoice and packing note should be sent simultaneously by airmail to expedite clearance through customs. In the case of instruments which require repair outside the warranty period, an immediate quotation can be provided when obtaining the RA number.
5. Track the progress on line at [www.megger.com](http://www.megger.com).

## 22. Decommissioning

---

### 22.1 WEEE Directive

The crossed out wheeled bin symbol placed on Megger products is a reminder not to dispose of the product at the end of its life with general waste.



Megger is registered in the UK as a Producer of Electrical and Electronic Equipment.  
The Registration No is WEE/ HE0146QT.

For further information about disposal of the product consult your local Megger company or distributor or visit the Megger website: [www.megger.com](http://www.megger.com)

### 22.2 Battery disposal

The crossed out wheeled bin symbol placed on a battery is a reminder not to dispose of batteries with general waste when they reach the end of their usable life.



The battery, is located under the battery cover on the back of the instrument. To remove the battery follow the instructions in **Refer to 18.3 Batteries and battery replacement on page 101.**

For disposal of batteries in other parts of the EU contact your local Megger branch or distributor.

Megger is registered in the UK as a producer of batteries (registration No.: BPRN00142).

For further information see [www.megger.com](http://www.megger.com)

## 23. Worldwide Sales Offices

| Sales Office         | Telephone                | Email                     |
|----------------------|--------------------------|---------------------------|
| UK                   | T. +44 (0)1 304 502101   | E. UKsales@megger.com     |
| USA – Dallas         | T. +1 214 333 3201       | E. USsales@megger.com     |
| USA – Valley Forge   | T. +1 214 333 3201       | E. USsales@megger.com     |
| USA – Dallas         | T. +1 214 333 3201       | E. USsales@megger.com     |
| DEUTSCHLAND – Aachen | T. +49 (0) 241 91380 500 | E. info@megger.de         |
| SVERIGE              | T. +46 08 510 195 00     | E. seinfo@megger.com      |
| AUSTRALIA            | T. +                     | E. AUSales@megger.com     |
| 中国                   | T. +86 512 6556 7262     | E. meggerchina@megger.com |
| 中国 - 香港              | T. +852 26189964         | E. meggerchina@megger.com |
| ČESKÁ REPUBLIKA      | T. +420 222 520 508      | E. info.cz@megger.com     |
| AMÉRICA LATINA       | T. +1 214 330 3293       | E. csasales@megger.com    |
| ESPAÑA               | T. +34 916 16 54 96      | E. info.es@megger.com     |
| SUOMI                | T. +358 08 510 195 00    | E. seinfo@megger.com      |
| LA FRANCE            | T. +01 30 16 08 90       | E. infos@megger.com       |
| ΕΛΛΑΔΑ               | T. +49 (0) 9544 68 0     | E. sales@sebakmt.com      |
| MAGYARORSZÁG         | T. +36 1 214-2512        | E. info@megger.hu         |
| ITALIA               | T. +49 (0) 9544 68 0     | E. sales@sebakmt.com      |
| 日本                   | T. +44 (0)1 304 502101   | E. UKsales@megger.com     |
| 한국                   | T. +1-800-723-2861       | E. sales@megger.com       |
| ضاي رل اة بربع ال    | T. +966 55 111 6836      | E. MESales@megger.com     |
| ن ح ر ب ل اة ك ل م م | T. +973 17440620         | E. MESales@megger.com     |
| NEDERLAND            | T. +46 08 510 195 00     | E. seinfo@megger.com      |
| NORGE                | T. +46 08 510 195 00     | E. seinfo@megger.com      |
| POLSKA               | T. +48 22 2809 808       | E. info.pl@megger.com     |
| PORTUGAL             | T. +34 916 16 54 96      | E. info.es@megger.com     |
| ROMÂNIA              | T. +40 21 2309138        | E. info.ro@megger.com     |
| РОССИЯ               | T. +7 495 2 34 91 61     | E. sebaso@sebaspectrum.ru |
| SLOVENSKO            | T. +421 2 554 23 958     | E. info.sk@megger.com     |
| SOUTH AFRICA         | T. + 27 (031) 576 0360   | E. sales.rsa@megger.com   |
| TÜRKIYE              | T. +46 08 510 195 00     | E. seinfo@megger.com      |

# CertSuite™

# Megger®

## Certification software

Cloud based certification for  
PC, Mac, Android, iOS,  
smartphones and tablets.



This software package  
also includes:

- Unlimited certificate generation
- Free technical support
- Continuously updated certification and features
- Fully secure Microsoft® Azure® cloud

Visit [Certsuite.info](http://Certsuite.info)  
for more information  
or scan the QR code



[www.megger.com](http://www.megger.com)

## Local Sales office

---

Megger Limited  
Archcliffe Road  
Dover  
Kent  
CT17 9EN  
ENGLAND  
T. +44 (0)1 304 502101  
F. +44 (0)1 304 207342

## Manufacturing sites

---

Megger Limited  
Archcliffe Road  
Dover  
Kent  
CT17 9EN  
ENGLAND  
T. +44 (0)1 304 502101  
F. +44 (0)1 304 207342

Megger GmbH  
Weststraße 59  
52074 Aachen  
GERMANY  
T. +49 (0) 241 91380 500  
E. info@megger.de

Megger Valley Forge  
400 Opportunity Way  
Phoenixville,  
PA 19460  
USA  
T. +1 610 676 8500  
F. +1 610 676 8610

Megger USA - Dallas  
4545 West Davis Street  
Dallas TX 75211-3422  
USA  
T. 800 723 2861 (USA only)  
T. +1 214 333 3201  
F. +1 214 331 7399  
E. USsales@megger.com

Megger AB  
Rinkebyvägen 19, Box 724,  
SE-182 17  
Danderyd  
SWEDEN  
T. +46 08 510 195 00  
E. seinfo@megger.com

Megger USA - Fort Collins  
4812 McMurry Avenue  
Suite 100  
Fort Collins CO 80525  
USA  
T. +1 970 282 1200

**This instrument is manufactured in the United Kingdom.**

**The company reserves the right to change the specification or design without prior notice.**

**Megger is a registered trademark**

**The Bluetooth<sup>®</sup> word mark and logos are registered trademarks owned by Bluetooth SIG Inc., and is used under licence.**